



Final Report for the NCC Grant
Development of a Low-Cost GSM Telephone
System for Rural Areas

Professor Francis Enejo Idachaba

Department of Electrical and Information Engineering
Covenant University Ota
Ogun State Nigeria

July 2021

Table of Contents

Executive Summary	6
Chapter One	7
INTRODUCTION	7
1.0 Introduction.....	7
1.1 Background.....	7
1.2 GSM Frequency Allocation to Operators in Nigeria	7
1.3 Transceiver Systems	8
Chapter Two	10
METHODOLOGY.....	10
2.1 Transceiver Design.....	10
2.2 Chip Selection	10
2.3 Design for Uplink (1710-1785MHz)	10
2.4. Design for Downlink (1805 – 1880MHz).....	13
2.5 Determination of Transceiver Parameters.....	16
2.6 Tower Construction	21
2.6.1 The Antenna Head.....	22
2.6.2. The Extender Sections.	23
2.6.3. The Base Section.....	24
2.7 Antenna Subsystem.....	26
2.7.1. Directional Antenna.....	26
2.7.2. Omnidirectional Antenna	26
2.8. Complete Transceiver Installation Package.....	27
Chapter Three.....	28
TESTS AND RESULTS	28
3.1 System Test.....	28
3.1.1. Voltage and Current consumption Tests.....	28
Lab Based Frequency Response Test.....	28
Field Tests.....	31
Tests in Ota.....	31
Tests in Abuja	33
Transceiver Add on Board tests.....	35
Transceiver with Add-On Board Test.....	36

Chapter Four.....	37
ANALYSIS AND DISCUSSION OF RESULTS	37
4.1 Pathloss computation.....	37
4.2 Determination of Transceiver Range.....	41
4.3 Discussion	43
4.4 Capacity Building Benefits of the project	44
4.5 Relevance to the Telecommunications Industry.....	44
Chapter Five.....	46
CONCLUSIONS AND RECOMMENDATION	46
5.1 Conclusion	46
5.2 Recommendation	46
References.....	48
Appendix A	50
Appendix B.....	57
Appendix C.....	71
Appendix D	85

List of Figures

Figure 1. Spectrum allocation for GSM Operators in Nigeria (Source NCC).....	8
Figure 2. Transceiver Block diagram	8
Figure 3. Designed Transceiver Block Diagram.....	18
Figure 4. Transceiver schematic diagram.....	18
Figure 5. Produced PCB	19
Figure 6. Transceiver installation in the casing.....	20
Figure 7. Tower Construction.....	21
Figure 8. Antenna Head.....	22
Figure 9. The Extender sections	23
Figure 10. Base section.....	24
Figure 11. Antenna Head and Base section.....	25
Figure 12. Directional antenna	26
Figure 13. Omni Directional Antenna	26
Figure 14. Complete Transceiver Installation Package	27
Figure 15. Power supply test setup.....	28
Figure 16. Lab test layout.....	28
Figure 17. Lab test setup	29
Figure 18. Spectrum Trace with Phone Bluetooth on and Transceiver OFF.....	29
Figure 19. Spectrum Trace with Phone Bluetooth on and Transceiver On	30
Figure 20. Spectrum Trace with Phone Bluetooth on and Transceiver On	30
Figure 21. Spectrum Trace with TRX off	31
Figure 22. Spectrum trace with TRX ON.....	31
Figure 23. Spectrum trace with TRX ON.....	32
Figure 24. Spectrum trace with TRX ON.....	32
Figure 25. Spectrum Trace with TRX OFF.....	33
Figure 26. Spectrum Trace with TRX ON	33
Figure 27. Spectrum Trace with TRX ON	33
Figure 28. Spectrum Trace with TRX ON	34
Figure 29. Direct Connection to Spectrum Analyzer with TRX OFF.....	34
Figure 30. Direct Connection to Spectrum Analyzer with TRX OFF.....	34
Figure 31. Add-On Board test with Signal generator set to 1750MHz and Board OFF	35
Figure 32. Add-On Board test with Signal generator varied from 1700MHz to 1780MHz with Add-On Board ON	35
Figure 33. Add-On Board test with Signal generator varied from 1700MHz to 1900MHz with Add-On Board ON	35
Figure 34. Average frequency response test with TRX OFF	36
Figure 35. Average frequency response test with TRX OFF	36
Figure 36. Transciever link diagram	42

List of Tables

Table 1. Component parts of the transceiver block diagram and their functions.....	9
Table 2. Specifications for HMC375LP3 (LNA chip)	10
Table 3. Specifications for SAFCC1G74KA0T00 (SAW filter).....	11
Table 4. Specifications for HMC380QS16G (Down conversion mixer)	11
Table 5. Specifications for 855625 (Intermediate Frequency filter)	12
Table 6. Specifications for ADL5530 (Gain Block).....	12
Table 7. Specifications for MAX2039 (Up converter).....	12
Table 8. Specifications for HMC457Q16G (Power amplifier chip).....	13
Table 9. Specifications for SAWEP1G84CQ0F00 (SAW filter)	13
Table 10. Specifications for ADF1800 (Duplexer)	13
Table 11. Specifications for TOM9211 (VCO chip).....	14
Table 12. Selected components and their gain and noise figure parameters	16
Table 13.. Transceiver specifications	17
Table 14. Transceiver Components Specifications	19
Table 15. Power supply test results	28
Table 16. TX and RX Spectrum allocation for Operators in Nigeria.....	31
Table 17. Pathloss coefficient for different environments [16 – 20].....	37
Table 18. Transceiver specifications	39
Table 19. Mobile station transmit power.....	39
Table 20. Power Control Steps for GSM 900 and DCS 1800	40
Table 21. Table Mobile Phone sensitivity tests	41
Table 22. Frequency and wavelength distribution for the uplink and downlink paths.....	42

Executive Summary

Access to communication service is a key challenge faced by dwellers in the rural areas of many developing countries and Nigeria in particular. The key reasons for this challenge include, the lack of the required subscriber base needed to justify such an investment, the lack of public utility power which means that operators will have to rely solely on diesel powered generator systems for providing power to the cell sites. In view of the lack of the required number of subscribers in the rural areas to justify the investment in setting up cell sites in rural areas coupled with the lack of public utility supply in these areas, for operators to deploy telecommunication service in rural areas, they would need a low-cost infrastructure that is both scalable and capable of running on renewable energy.

This work was able to execute the development of a low power bidirectional transceiver system for the implementation of a low-cost GSM telephone system for rural areas. Several events which impacted on the delivery time provided learning opportunities which will go a long way to enhance the capacity required for the manufacture of telecommunication equipment in the country. One of these events is the unwillingness of component resellers and some equipment manufacturers to ship their merchandise to Nigeria. The other challenge is the limited design skills and the availability of the required software and hardware systems and equipment for the design, production, and testing of the prototypes. There is a need for the continuous and deliberate investment in the required design and prototyping equipment and the support for the commercialization of these equipment for use in the country. This will create jobs and enhance the technology sufficiency of the Nation while at the same time contributing to the national GDP and reducing capital flight. This project has proved the capability of the team to both design and develop this critical component part of the communication infrastructure. There is a need to further advance this work to the development of the production model of this transceiver (harnessing all the learning from this phase of the work), commercializing, and deploying the system in rural areas in Nigeria. This will ensure the maturity of the skills acquired in this project, enable the development of a Nigerian product for the Telecommunication industry. It will also enhance the capacity for further infrastructure development for new technologies such as the 5G communication Infrastructure and other security critical infrastructure which the country currently needs.

Chapter One

INTRODUCTION

1.0 Introduction

This report presents the research findings from the NCC research grant awarded for the development of a Low-Cost GSM Telephone system for Rural Areas. The project involves the design and development of a Low-Cost Bidirectional Transceiver prototypes which is to be tested in a rural community. This report details the design of the transceiver, the Tower and antenna components and the both the field and laboratory test results.

1.1 Background

The grant was awarded with a duration of one year and the first tranche of the grant payment was released to the researchers to commence the project. The initial items required for the work which include the laptops, printers and stationaries were procured and the engagement of the required personnel commenced. The preliminary design was also commenced and within the stipulated period, the design was completed, and the phase two activities were initiated. The components required for the project were identified and the equipment required for the project was also identified and orders were initiated. However, the component reseller with the bulk of the components declined selling to the team on the account that the team was based in Nigeria and the identified PCB machine used for the quote was discontinued and the changes in the foreign exchange took the cost of the spectrum analyzer out of the budget estimates. These challenges were reported to the Commission, and it necessitated a modification of the project implementation strategy. The team approached the commission for a modification of the payment plans requesting the combination of the second and third tranches of the payment to enable the team to procure some of these equipment and proceed with the revised strategy.

1.2 GSM Frequency Allocation to Operators in Nigeria

The system design began with the review of the spectral allocations to the different GSM operators. Table 1 shows the Uplink and Downlink frequency pairs for the different

operators and the colour codes associated with the different operators. Figure 1 shows the spectrum allocation for the different GSM operators in Nigeria.

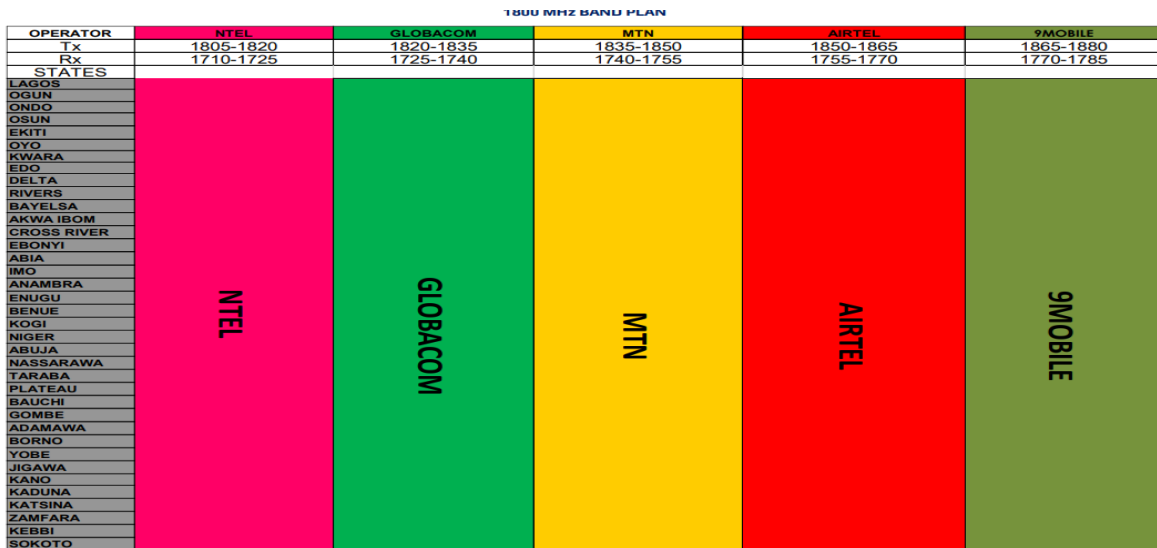

Figure 1. Spectrum allocation for GSM Operators in Nigeria (Source NCC)

1.3 Transceiver Systems

A transceiver can be defined as a device for receiving and retransmitting signals. It comprises of a receiver and transmitter connected in cascade where the output of the receiver is fed to the input of the transmitter. Transceivers can be classified based on the operations performed on the received signals. Figure 2 shows a transceiver block diagram and the different component parts.

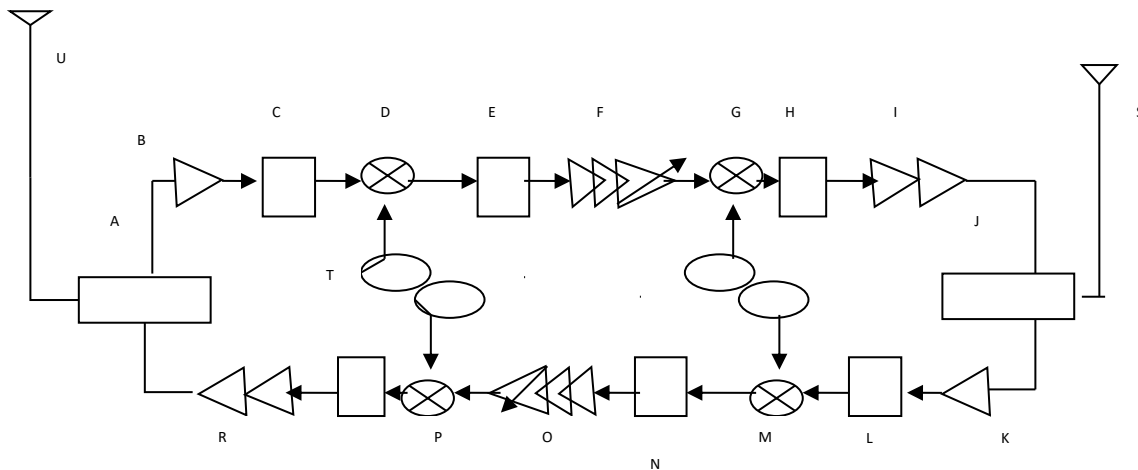

Figure 2. Transceiver Block diagram

Table 1 shows the identities of the different blocks that makeup the transceiver and the function of each block.

Table 1. Component parts of the transceiver block diagram and their functions.

Symbol	Block	Function
A	Duplexer A	Enables the use of one antenna for simultaneous reception and transmission of RF signals
B	LNA	Amplifies the incoming RF signal with little addition of noise
C	Image reject filter (DL)	Band pass filter used for blocking the image signals, it defines the RF band
D	Down conversion mixer	Performs the down conversion frequency translation
E	IF BPF	Performs the selection of the IF signals
F	IF Amplifier (Variable)	Amplifies the IF signal
G	Upconversion mixer (DL)	Performs the upconversion frequency translation
H	Image reject filter (DL)	Band pass filter used for blocking the image signals it defines the RF band
I	Power amplifier	Performs power amplification of the signal before transmission via the antenna
J	Duplexer B	Enables the use of one antenna for simultaneous reception and transmission of RF signals
K	LNA	Amplifies the incoming RF signal with little addition of noise
L	Image reject filter (UL)	Band pass filter used for blocking the image signals it defines the RF band
M	Down conversion mixer	Performs the down conversion frequency translation
N	IF BPF	Performs the selection of the IF signals
O	IF Amplifier	Amplifies the IF signal
P	Upconversion mixer (UL)	Performs the upconversion frequency translation
Q	Image reject filter (UL)	Band pass filter used for blocking the image signals it defines the RF band
R	Power amplifier	Performs power amplification of the signal before transmission via the antenna
S	Antenna (Yagi)	Couples RF signals from the BTS to the transceiver
T	Voltage controlled oscillators	Provides the local oscillator signal
U	Antenna (corner reflector)	Couples RF signals from the transceiver to the user

Chapter Two

METHODOLOGY

2.1 Transceiver Design

The first step in transceiver design involves the selection of the desired topology. After the desired topology has been selected, the components with the required parameters are then selected based on the target specification. Application Specific Integrated Circuits (ASICs) which are specially designed integrated circuits chips for specific applications are then selected for the design such that the target specifications are achieved.

2.2 Chip Selection

The various ASIC chips for the implementation of each of the blocks of the system to meet the ETSI specification are identified and used in the system design.

2.3 Design for Uplink (1710-1785MHz)

(a) Low Noise Amplifier (LNA)

From the initial specifications, the LNA has the following requirements.

1. Low noise figure $< 2\text{dB}$
2. High gain $> 15\text{dB}$. The gain should be high enough to achieve the required noise figure but low enough not to affect the mixer's linearity.
3. 50Ω input impedance
4. low power consumption
5. Frequency range 1710-1785MHz

The chip selected was the HMC375LP3. Table 2 shows some of its parameters.

Table 2. Specifications for HMC375LP3 (LNA chip)

CHIP	GAIN	NOISE FIGURE	FREQUENCY RANGE	OIP ₃	MANUFACTURER
HMC375LP3	17.5	0.9	1.7-2.2GHz	34	Hittite Microwave

(b) The Surface Acoustic Wave (SAW) Filter

This filter is responsible for ensuring that only the uplink band can pass through. The SAW filter removes the image frequency of the mixers stage. The filter used was based on the SAW technology.

The specifications of the filter include:

1. Fc(center frequency) = 1747.5 ± 35 MHz
2. Low insertion loss

The filter used is the SAFCC1G74KA0T00. Table 3 shows some specifications of the filter

Table 3. Specifications for SAFCC1G74KA0T00 (SAW filter)

FILTER	GAIN	NF	OIP ₃	FREQUENCY	MANUFACTURER
SAFCC1G74KA0T00	-4.2	4.5	100	1710 – 1785MHz	Murata Corp

(c) The Down converter Mixer stage

The mixer used was an active mixer. This was chosen over the passive filter type as it had conversion gain which further reduced the system noise figure.

The mixer chosen is the HMC380QS16G based on the following specifications.

Intermediate Frequency is chosen to be 190MHz.

RF = 1.7GHz – 2.2GHz

IF = 50 – 300MHz

Table 4. Specifications for HMC380QS16G (Down conversion mixer)

MIXER	GAIN	NF	IIP ₃	FREQUENCY	MANUFACTURER
HMC380QS16G	11dB	9dB	19	RF=1.7 - 2.2GHz IF= 50 - 300MHz	Hittite Microwave Corp

(d)The Intermediate Frequency (IF) Filter

The IF is chosen to be 190MHz. A GSM channel has a bandwidth of 200 KHz. The IF filter determines the number of channels the system can handle. The chip selected is the MP01102.

Table 5. Specifications for 855625 (Intermediate Frequency filter)

SAW filter	GAIN	NF	OIP ₃	F _c	B/W	MANUFACTURER
MP01102						Golledge

(e) Gain Blocks

The bulk of the system gain is added at the intermediate frequency level.

The ADL5530 is used to provide this gain and it has the following specifications.

Table 6. Specifications for ADL5530 (Gain Block)

CHIP	GAIN	NF	OCP	OIP ₃	FREQUENCY	B/W	MANUFACTURER
ADL5530	16	2.5	22dB	37dBm	0 – 1GHz	1GHz	Analog Devices

(f) The Up-conversion Mixer

The MAX2039 upconverter mixer was used. The effect of its conversion loss is negligible due to its position in the chain. It consumes less power since it does not amplify. Its specifications include:

Table 7. Specifications for MAX2039 (Up converter)

CHIP	GAIN	NF	IIP ₃	FREQUENCY	MANUFACTURER
MAX 2039	-7.1	7.3	33.5dBm	RF = 1.7 -2.2GHz LO = 1.5 – 2.0GHz IF = 0 – 350MHz	maxim-ic inc.

(g)The Image Reject Filter

The same SAFCC1G74KA0T00 is used since the frequencies are the same.

(h) The Power Amplifier

The power amplifier is required to have a high gain, and also be able to operate in the 1710 -1785MHz range. The PA chip HMC457Q16G selected has the following specifications.

Table 8. Specifications for HMC457Q16G (Power amplifier chip)

CHIP	GAIN	NF	IIP ₃	FREQUENCY	MANUFACTURER
HMC457Q16G	27dB	6dB	46dBm	1.7 – 2.2GHz	Hittite Microwave Corp

2.4. Design for Downlink (1805 – 1880MHz)

From the frequency distribution of the system, the same IF frequency value is used for the uplink and downlink, the chips that differentiate both links are the image reject filters.

(a) The SAW IR

The filter selected was the SAWEPIG84CQ0F00 SAW filter. Its specifications are listed in Table 9.

Table 9. Specifications for SAWEPIG84CQ0F00 (SAW filter)

CHIP	GAIN	NF _{dB}	OIP	F _C	BW	MANUFACTURER
SAWEPIG84CQ0F00	-2.5	2.5	100	1842.5MHz	75MHz	Murata Corp

The Duplexer

The transceiver will utilize the same antenna for both receive and transmit so a duplexer would be required to separate both channels. The duplexer chosen for the system is the ADF1800.

Specification for the duplexer is shown in table 10.

Table 10. Specifications for ADF1800 (Duplexer)

CHIP	GAIN	NF	OIP ₃	FREQUENCY(MHz)	MANUFACTURER
ADF1800	-2dB	2dB	100	Uplink frequency = 1710 – 1785 Downlink frequency = 1805 - 1880	Avantelsoft inc

(b) THE VOLTAGE CONTROLLED OSCILLATOR (VCO)

With the choice of 190MHz (0.19GHz) for the intermediate frequency, the required VCO or local oscillator (LO) frequency range is determined from the equations below.

$RF - LO = IF$

Thus

$LO_{min} = RF_{min} - IF$

$LO_{max} = RF_{max} - IF$

From equations and the LO range for the uplink and downlink is computed as follows.

For Uplink

$$LO_{\min} = 1.710\text{GHz} - 0.19\text{GHz} = 1.520\text{GHz}$$

$$LO_{\max} = 1.785\text{GHz} - 0.19\text{GHz} = 1.595\text{GHz}$$

For Down link

$$LO_{\min} = 1.805\text{GHz} - 0.19\text{GHz} = 1.615\text{GHz}$$

$$LO_{\max} = 1.880\text{GHz} - 0.19\text{GHz} = 1.690\text{GHz}$$

From the chip specifications for the VCO, the required LO frequencies for an IF of 190MHz is from 1.52GHz to a maximum of 1.69GHz. A chip that will give this frequency value at low voltage is desired.

The selection of the mixer and Intermediate frequencies is done to enable the tune the transceiver to either one operator or multiple operators. This selection for the uplink portion of the spectrum for all the operators is shown in table 2. For this design, the mixer selected has a minimum and maximum frequency of 1520MHz and 1595MHz, respectively.

Table 11. Specifications for TOM9211 (VCO chip)

CHIP	FREQUENCY RANGE	TUNNING VOLTAGE	P _{OUT}	MANUFACTURER
TOM9211	1.5 to 2.75GHz	2 – 18V	+12dBm	Spectrum Microwave

Other transceiver parameters derived include.

System sensitivity

The system sensitivity is given by the equation.

$$S = \text{Sensitivity} = -174 \text{ dBm} + 10 \log (B) + \text{NF (dB)} + \text{SNR}_{\text{out}} \dots \dots \dots 1$$

Where N(in) dBm = K T

$$K = \text{Boltzmann's constant} = 1.38 \times 10^{-23} \text{ J/K}$$

$$T = \text{Temperature} = 290\text{K}$$

B = signal bandwidth, this is determined by the IF bandpass filter = 200 KHz

NF (dB) = System noise figure computed to be 4.07 dB

SNR_{out} = Output signal to noise ratio=assuming the DCS standard of 9dB

$$S = \text{Sensitivity} = -174 \text{ dBm} + 10 \log (200,000) + 4.07 \text{ (dB)} + 9\text{dB}$$

$$S = -174 + 53 + 4.07 + 9 = -107.93 \text{ dB}$$

Sensitivity = -107.93dB

Noise Floor

The noise floor is determined from the equation.

$$\text{Noise floor} = -174 \text{ dBm} + 10 \log (B) + \text{NF (dB)} \dots\dots\dots 2$$

$$\text{Noise floor} = -174 \text{ dBm} + 10 \log (200,000) + 4.07 \text{ (dB)} = -116.93\text{dB}$$

Minimum discernable signal

The minimum discernable signal is determined from the equation.

$$\text{Minimum discernable signal} = \text{Noise floor} + \text{Margin (3dB)} \dots\dots\dots 3$$

$$= -116.93 + 3 \text{ dB} = -113.93 \text{ dB}$$

The Intercept point

The output intercept point is calculated from the equation below,

$$OIP3 = \frac{1}{\frac{1}{G_{n-1}G_{n-2}G_{n-3}\dots\dots G_1 \cdot OIP3_n} + \frac{1}{G_{n-2}G_{n-3}\dots\dots G_1 \cdot OIP3_{n-1}} + \dots\dots + \frac{1}{OIP3_1}} \dots\dots\dots 4$$

$$OIP3_{\text{sys}} = 1234.74$$

$$OIP3 \text{ (dBm)} = 10 \log 1234.74 = 30.92\text{dBm}$$

$$OIP3(\text{dBm}) = 30.92\text{dBm}$$

The table 12 shows a comparison of the design specifications achieved and the target specifications.

Table 12. Selected components and their gain and noise figure parameters

Chip	NF(dB)	Gain(dB)
Duplexer ADF1800	2	-2
LNA HMC375LP3	0.9	17.5
Filter SAFCC1G74KA0T00	4.2	-4.2
Down converter Mixer HMC380QS16G	9	11
SAW IF FILTER 855625	6.6	-6.6
Gain Block ADL 5530	2.5	16
Gain Block ADL 5530	2.5	16
Up Converter MAX2039	7.3	-7.1
Filter SAFCC1G74KA0T00	4.2	-4.2
Power Amplifier HMC457QS1G	6	27
Power Amplifier HMC457QS1G	6	27
Duplexer ADF1800	2	-2
Total Gain(dB)		88.4

2.5 Determination of Transceiver Parameters

There are two approaches to the design of transceivers. These are.

- The use of the spreadsheets and
- The use of the simulation software with behavioral models.

The spreadsheets approach enables the determination of the system parameters in an easy and affordable manner while the relative costs of the simulation software in most cases tries to overcome its advantage of producing results that approximates real transceiver architecture performances.

The results of the spread sheet analysis is shown in table 13.

Table 13.. Transceiver specifications

Chip	Gain(dB)	NF(dB)	F(linear)	Gain (ratio)	Cascaded NF	OIP3(dB)	Input = -100dBm	Cascaded Gain (dB)	OIP3(linear)
Duplexer ADF1800	-2	2	1.584893	0.630957	1.584893192	100	-102	-2	10000000000
LNA HMC375LP3	17.5	0.9	1.230269	56.23413	0.364951407	34	-84.5	15.5	2511.886432
Filter SAFCC1G74KA0T00	-4.2	4.2	2.630268	0.380189	0.045947195	100	-88.7	11.3	10000000000
Down converter Mixer HMC380QS16G	11	9	7.943282	12.58925	0.514712631	30	-77.7	22.3	1000
SAW IF FILTER 855625	-6.6	6.6	4.570882	0.218776	0.021026911	100	-84.3	15.7	10000000000
Gain Block ADL 5530	16	2.5	1.778279	39.81072	0.020947661	37	-68.3	31.7	5011.872336
Gain Block ADL 5530	16	2.5	1.778279	39.81072	0.000526181	37	-52.3	47.7	5011.872336
Up Converter MAX2039	-7.1	7.3	5.370318	0.194984	7.42186E-05	26.4	-59.4	40.6	436.5158322
Filter SAFCC1G74KA0T00	-4.2	4.2	2.630268	0.380189	0.00014199	100	-63.6	36.4	10000000000
Power Amplifier HMC457QS1G	27	6	3.981072	501.1872	0.000682924	45	-36.6	63.4	31622.7766
Power Amplifier HMC457QS1G	27	6	3.981072	501.1872	1.36261E-06	45	-9.6	90.4	31622.7766
Duplexer ADF1800	-2	2	1.584893	0.630957	5.33429E-10	100	-11.6	88.4	10000000000
Total	88.4				2.553905676				
					0.407204853				
cascaded noise figure(dB)					4.072048534				

The designed transceiver block diagram is shown in figure 3

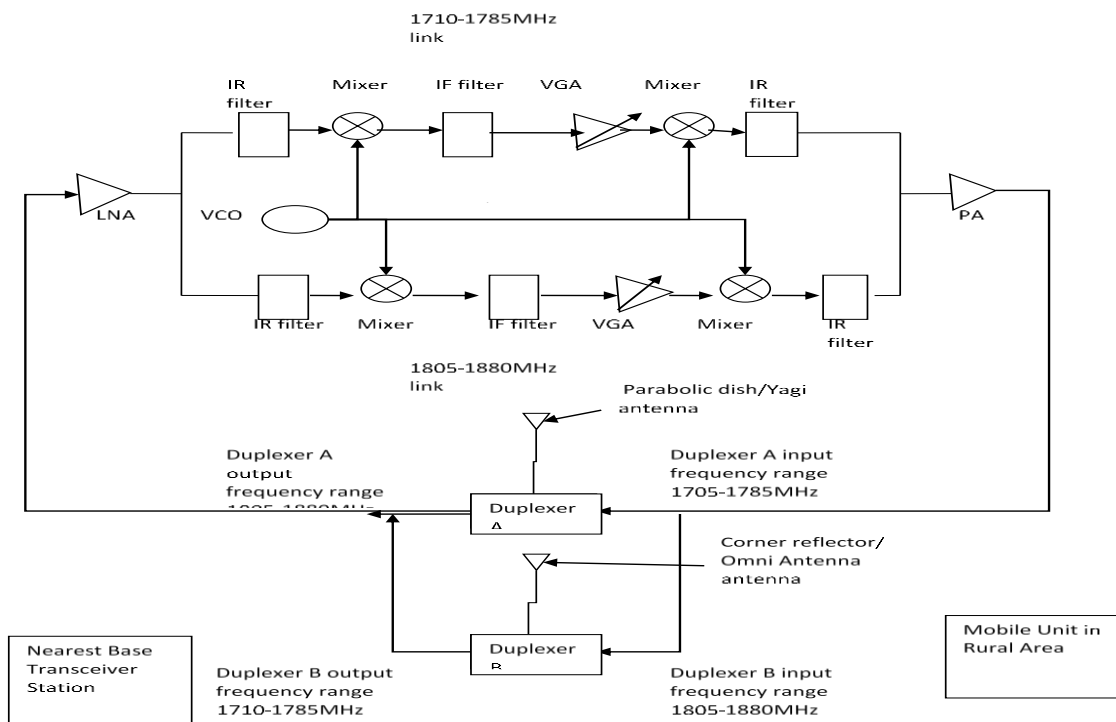

Figure 3. Designed Transceiver Block Diagram

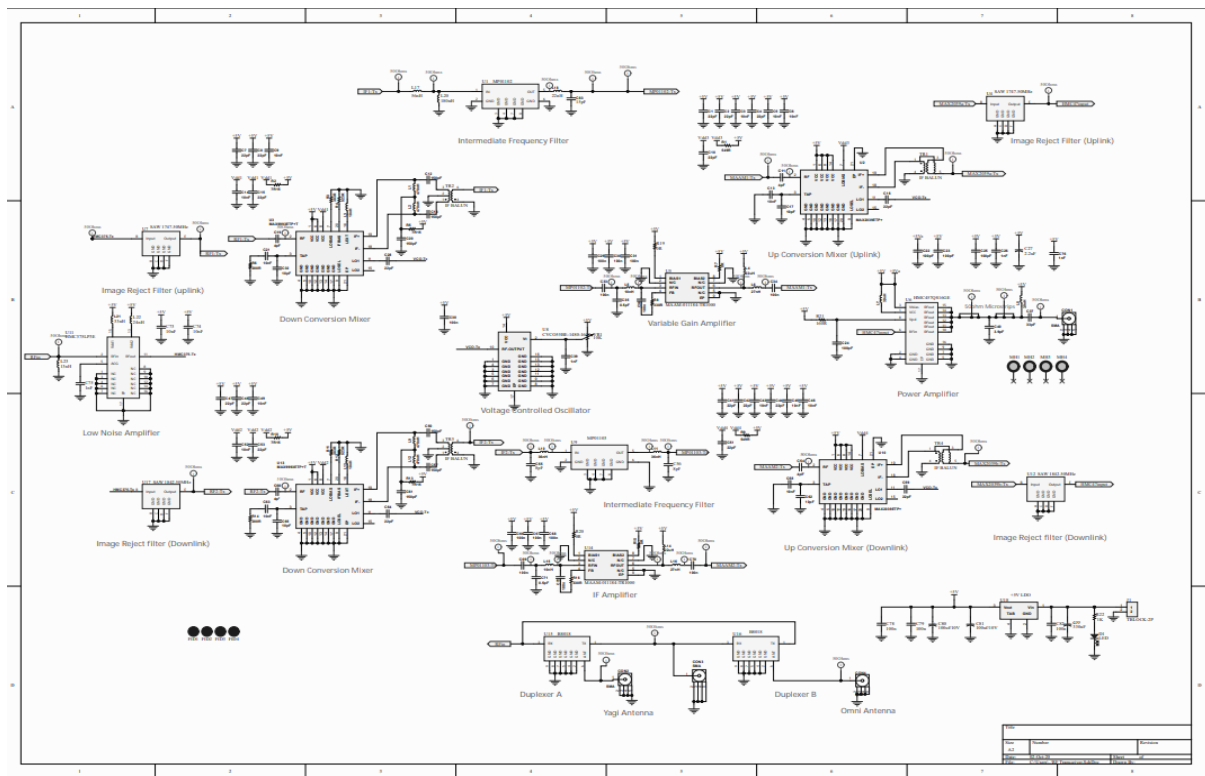

Figure 4. Transceiver schematic diagram

Table 4 shows the required transceiver components and their frequency specification.

Table 14. Transceiver Components Specifications

No	Item	Specs	Quantity
1	LNA	1710MHz - 1880MHz	1
2	PA	1710MHz - 1880MHz	1
3	VCO	1520MHz – 1595MHz	1
4	Image Reject Filter	1710MHz – 1785MHz	2
5	Intermediate Frequency filter	190MHz (BW 200KHz)	1
6	Variable gain Amplifier	190MHz (BW 200KHz)	1
7	Downconversion mixer	RF=1710MHz – 1785MHz, LO =1520MHz – 1595MHz	1
8	Up conversion mixer	RF=190MHz, LO =1520MHz – 1595MHz	1
9	Image Reject Filter	1805MHz – 1885MHz	2
10	Intermediate Frequency filter	285MHz (BW 200KHz)	1
11	Variable gain Amplifier	285MHz (BW 200KHz)	1
12	Downconversion mixer	RF=1805MHz – 1885MHz, LO =1520MHz – 1595MHz	1
13	Upconversion mixer	RF=285MHz, LO =1520MHz – 1595MHz	1
14	Duplexer Uplink	Input = 1805MHz-1885MHz Output = 1705MHz – 1880MHz	1
15	Duplexer Down link	Output = 1805MHz-1885MHz Input = 1705MHz – 1880MHz	1
16	Yagi Antenna	1705MHz – 1880MHz	2

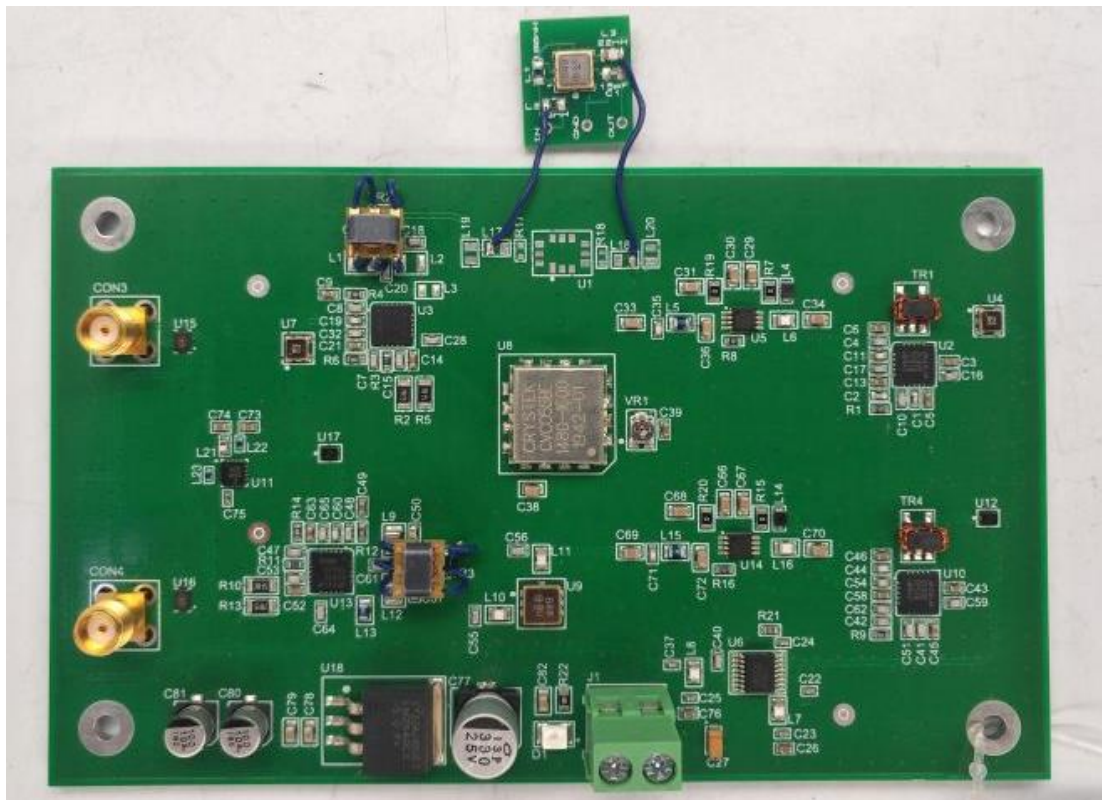

Figure 5. Produced PCB

The transceiver board is installed in a case and fans are used to enable the cooling of the transceiver as it operates. This installation of the transceiver in a casing is shown in figure below.



Figure 6. Transceiver installation in the casing

2.6 Tower Construction

The tower construction is shown in the figures below. The tower consist of 4 sections with a total height of 20ft with a support base.

The tower construction images are shown in figure 8



Figure 7. Tower Construction

The tower installation comprises of three subsections. These subsections are

1. The Antenna head
2. The Extenders
3. The Base

2.6.1 The Antenna Head

The combination of both the directional and Omnidirectional antennas are installed on the tower head and this section is known as the antenna head. It is shown in the figure 9



Figure 8. Antenna Head

2.6.2. The Extender Sections.

The extenders are sections of pipes designed to be used to extend the antenna height. For this project, two extender sections are included and can be both used to extend the tower or the mast height. The extenders are shown in the figure 10



Figure 9. The Extender sections

2.6.3. The Base Section

The base section showing the tripod base design is shown in the figure 11. This base is designed to support the tower height and keep it stable. It consists of three sections installed 120 degrees apart from each other and the length of which is designed to support the antenna height.



Figure 10. Base section

A combination of the tower and the antennas is shown in the figure 12. This installation comprises of the base section and the antenna head



Figure 11. Antenna Head and Base section

2.7 Antenna Subsystem

The antenna systems comprise of two types of antenna. These antennas are

2.7.1. Directional Antenna

The directional antenna is a high gain directional antenna used to connect the transceiver to the nearest base station. The directional antenna utilized for this project is shown in the figure 13.



Figure 12. Directional antenna

2.7.2. Omnidirectional Antenna

The Omnidirectional Antenna is used to provide coverage to the rural community. The omnidirectional antenna used is shown in the figure 14.



Figure 13. Omni Directional Antenna

2.8. Complete Transceiver Installation Package.

The complete transceiver solution showing the tower, the antenna, the transceiver, and the extender sections are shown in the figure 15.



Figure 14. Complete Transceiver Installation Package

Chapter Three

TESTS AND RESULTS

3.1 System Test

This chapter details the various tests carried out on the system and the results obtained.

3.1.1. Voltage and Current consumption Tests

These tests were carried out to determine the total power consumption of the transceiver board. The setup of the tests is shown in figure below.



Figure 15. Power supply test setup

Table shows the results of the Transceiver power consumption tests.

Table 15. Power supply test results

Voltage (Volts)	Current (Amps)	Power (Watts)
12	1.39	16.68

Lab Based Frequency Response Test.

The layout for the lab test is shown in figure 16.

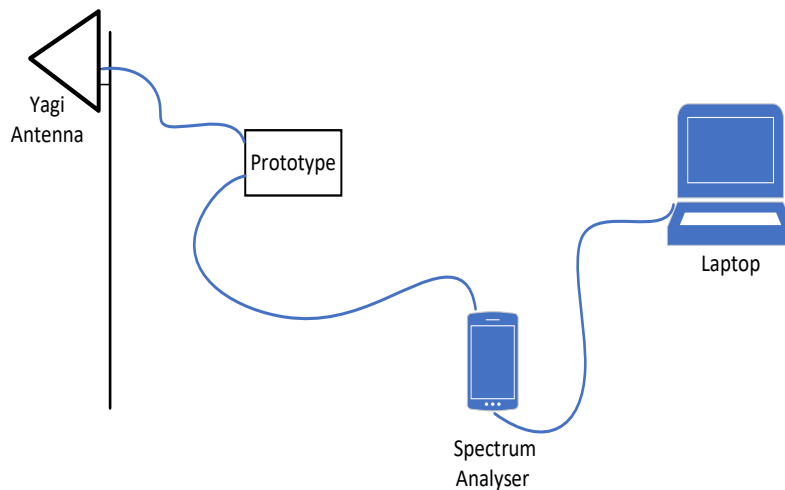

Figure 16. Lab test layout

The set up for the test is shown in figure 17. The prototype was connected to the spectrum analyzer which is a USB based spectrum analyzer. The directional antenna was used to link the prototype to the nearest BTS while the downlink was connected directly to the spectrum analyzer.



Figure 17. Lab test setup

The results from the lab test and the different simulation scenarios are shown in the figures 18 to 20.

(i) Transceiver Response to Bluetooth Signals

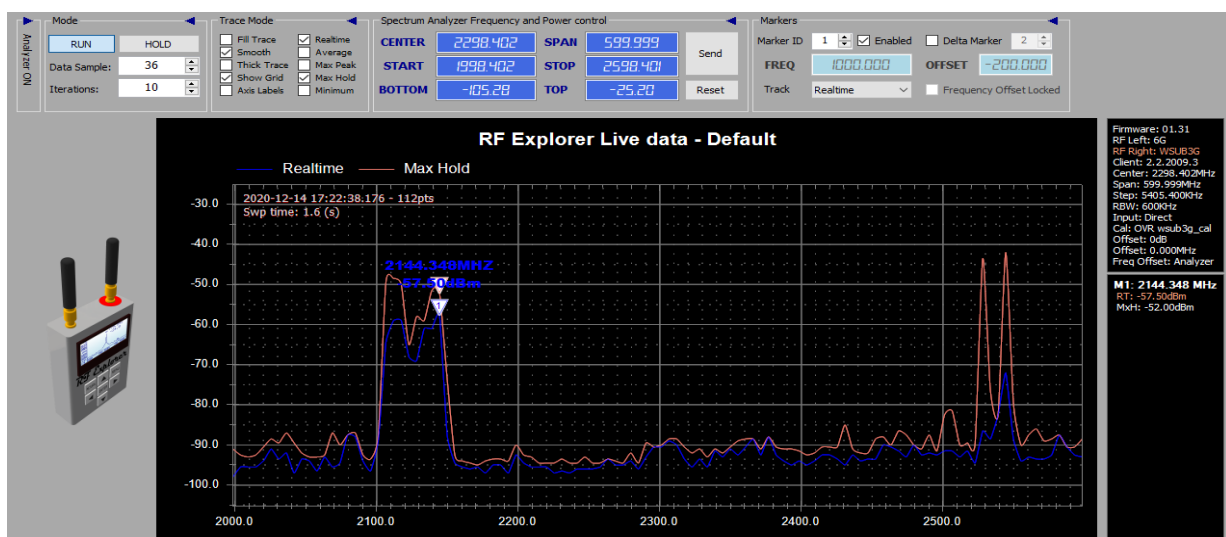

Figure 18. Spectrum Trace with Phone Bluetooth on and Transceiver OFF

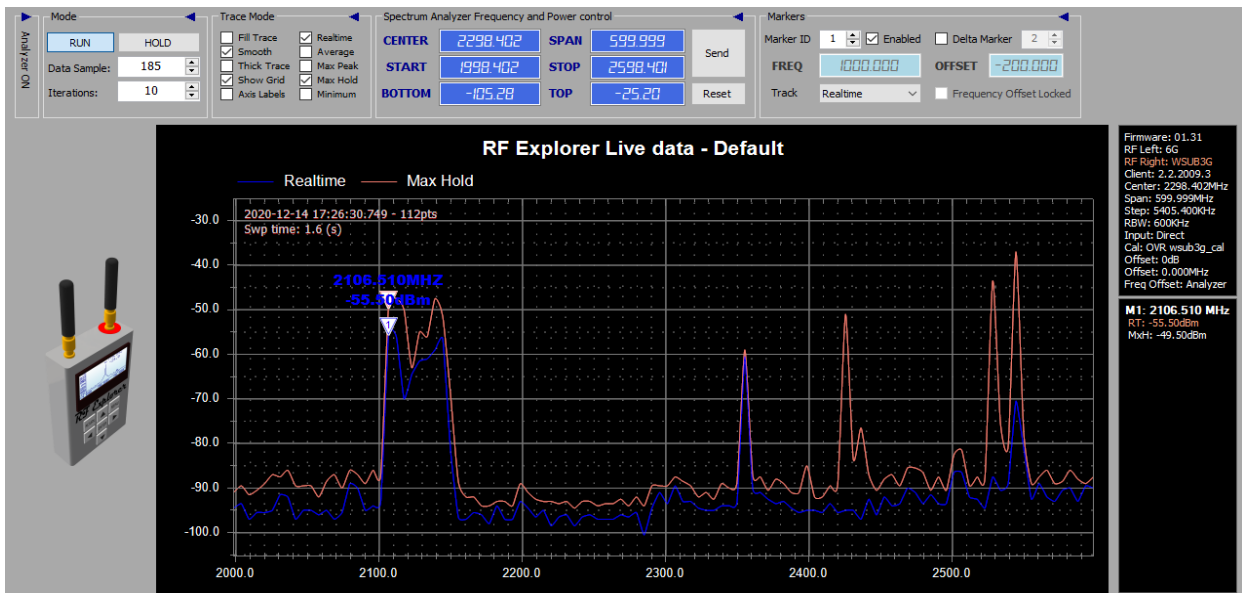

Figure 19. Spectrum Trace with Phone Bluetooth on and Transceiver On

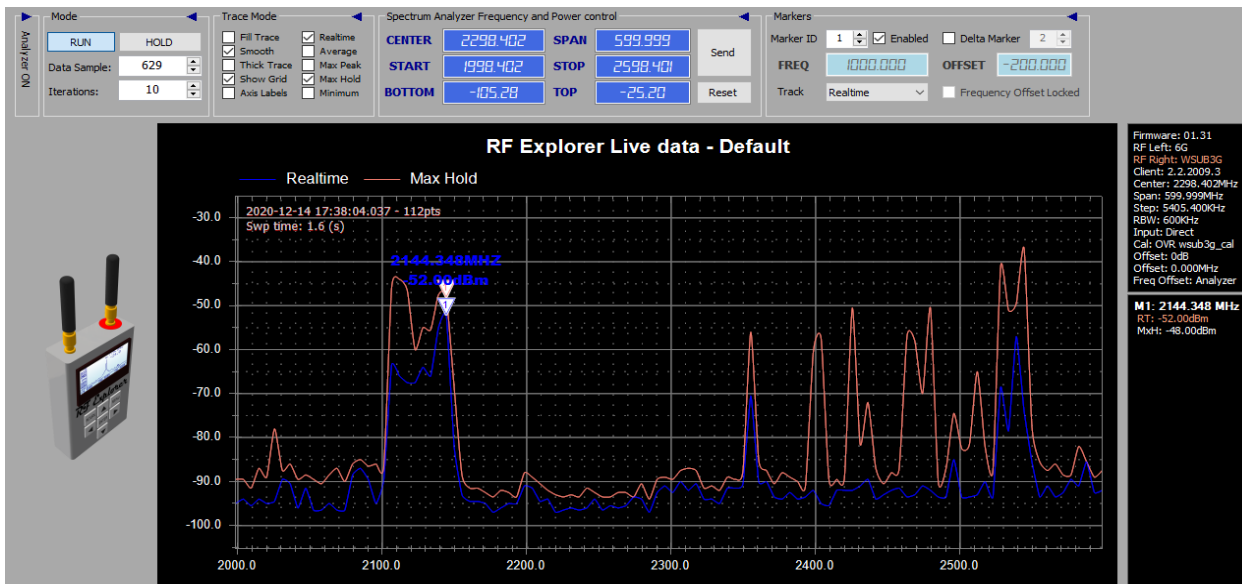

Figure 20. Spectrum Trace with Phone Bluetooth on and Transceiver On

The tests for the frequency response of the transceiver to Bluetooth signals is shown in the figures above. With the transceiver ON, there was a signal spike at the 2350MHz frequency. This response continued between 2350MHz and 2500MHz.

Field Tests

The Transceiver is designed to provide connectivity to the users in the rural areas by linking them to the nearest base station. The current list of operators in Nigeria and their allocated frequency spectrum showing both the transmit and the receive spectrum is shown in the table 16.

Table 16. TX and RX Spectrum allocation for Operators in Nigeria

OPERATOR	NTEL	GLOBACOM	MTN	AIRTEL	9MOBILE
Tx	1805-1820	1820-1835	1835-1850	1850-1865	1865-1880
Rx	1710-1725	1725-1740	1740-1755	1755-1770	1770-1785

Frequency response from 1700MHz to 1900MHz

This test was carried out to investigate the possible spectral response of the transceiver outside the GSM signal band and the results obtained are shown in the figures 24 to 26.

Tests in Ota

Transceiver Off (New Estate)

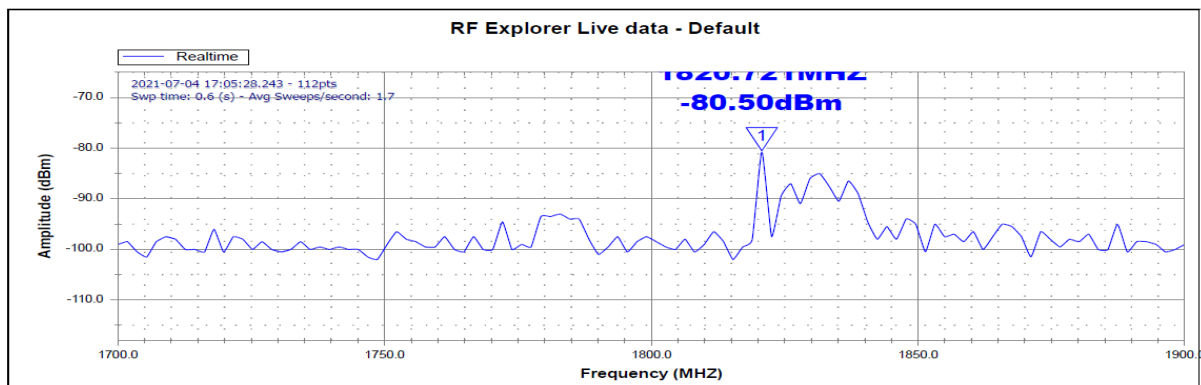

Figure 21. Spectrum Trace with TRX off

Transceiver ON (New Estate)

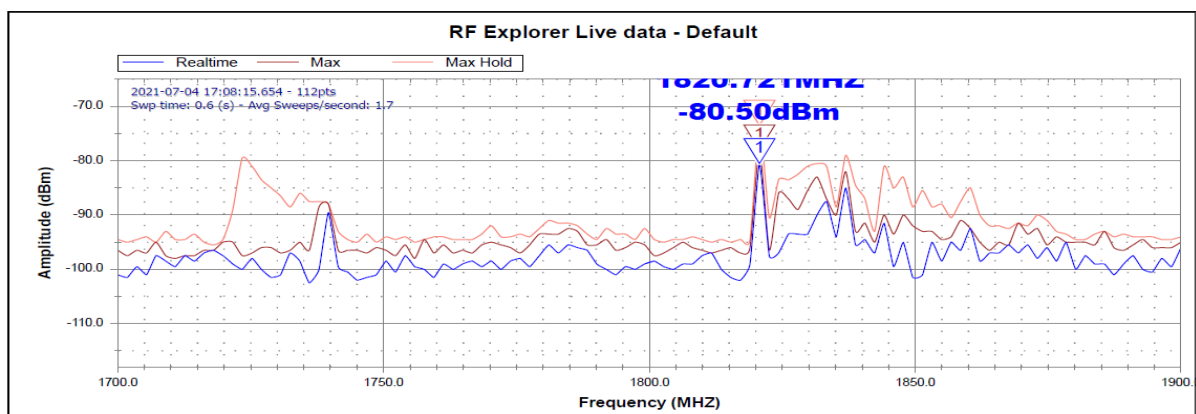

Figure 22. Spectrum trace with TRX ON

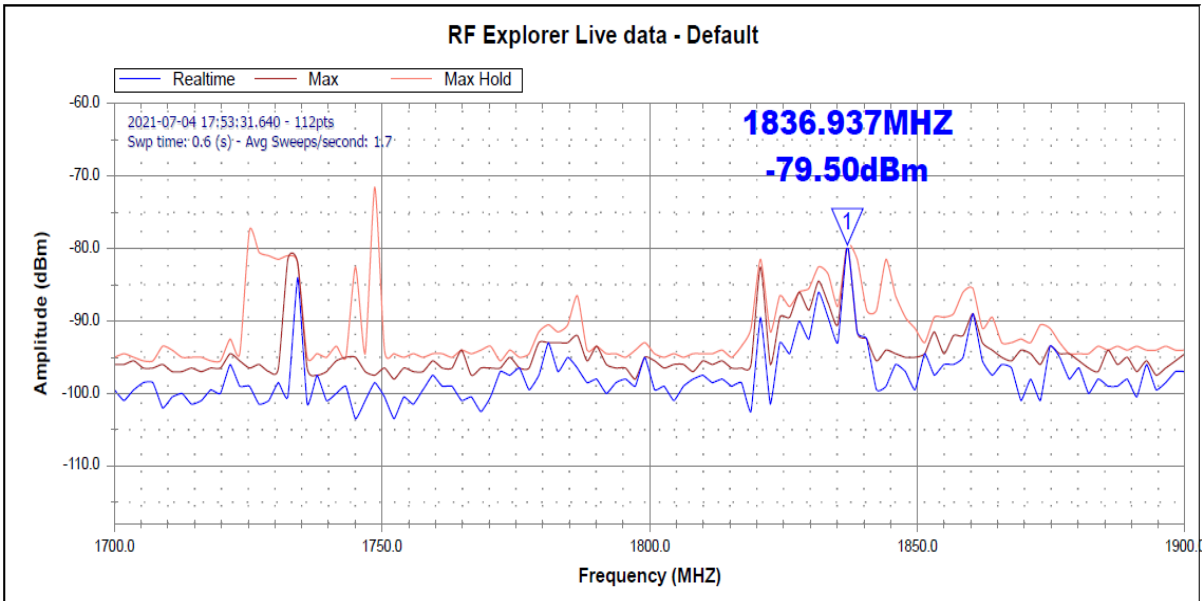

Figure 23. Spectrum trace with TRX ON

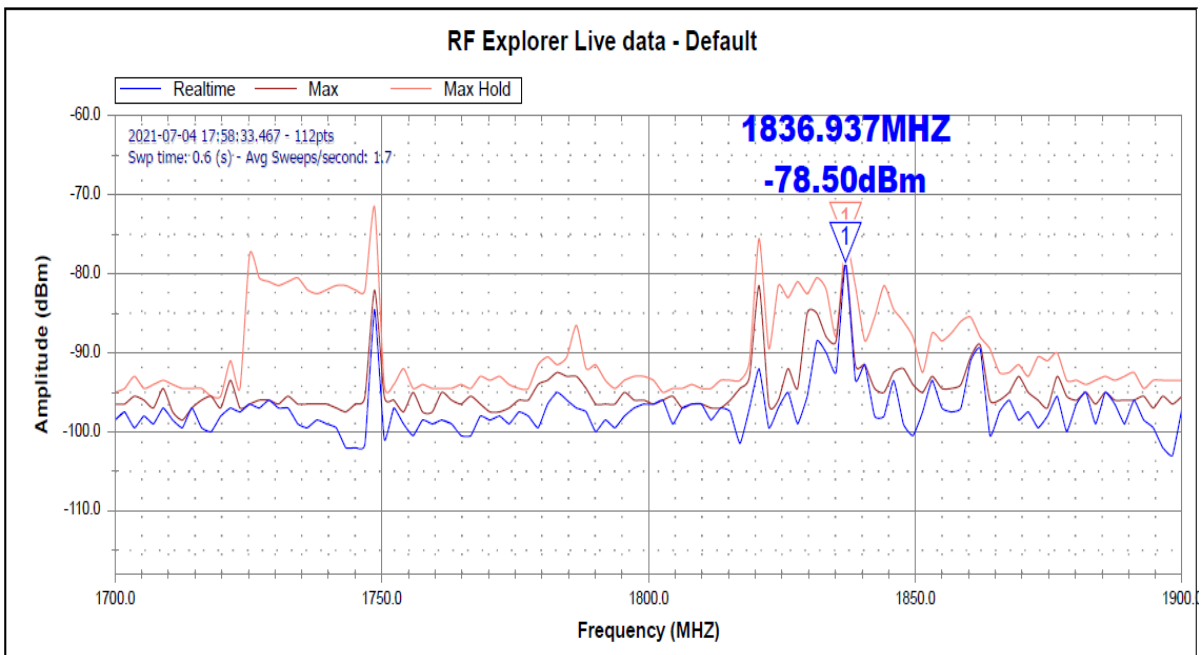

Figure 24. Spectrum trace with TRX ON

Tests in Abuja

Transceiver Off (Abuja Transcorp)

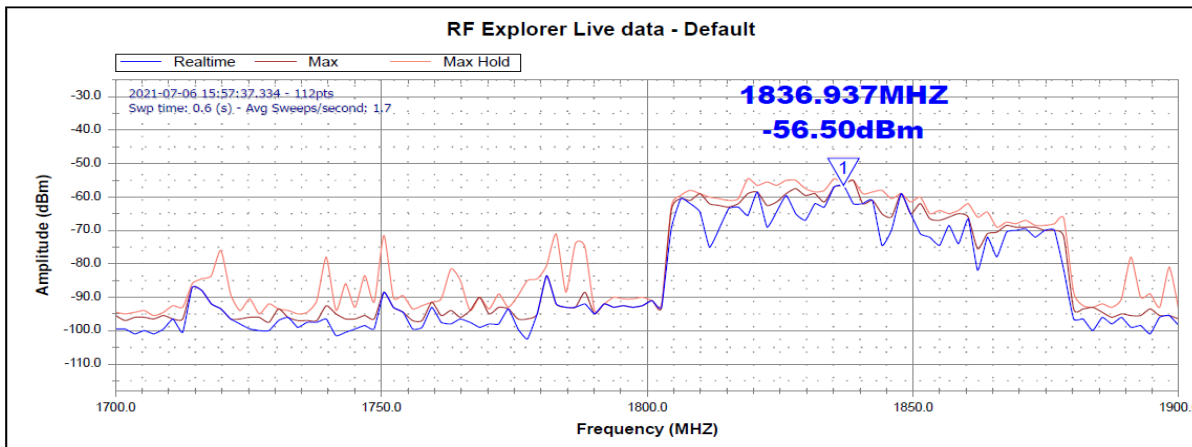

Figure 25. Spectrum Trace with TRX OFF

Transceiver ON (Abuja Transcorp)

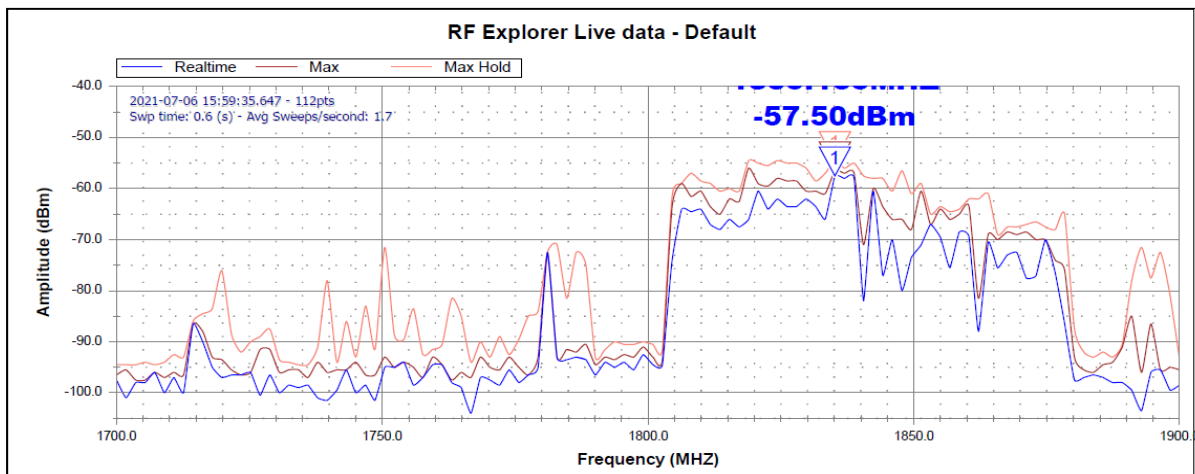

Figure 26. Spectrum Trace with TRX ON

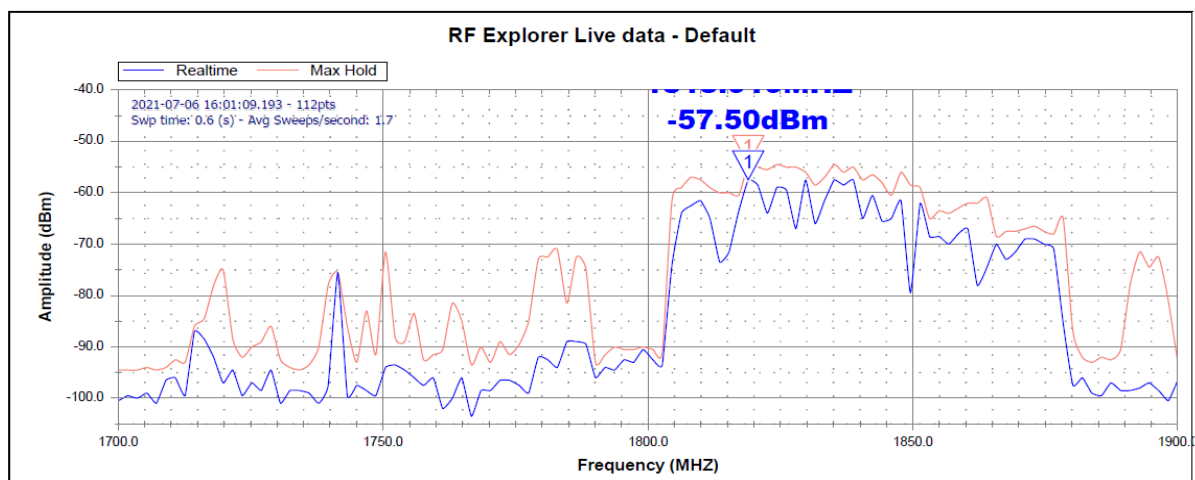

Figure 27. Spectrum Trace with TRX ON

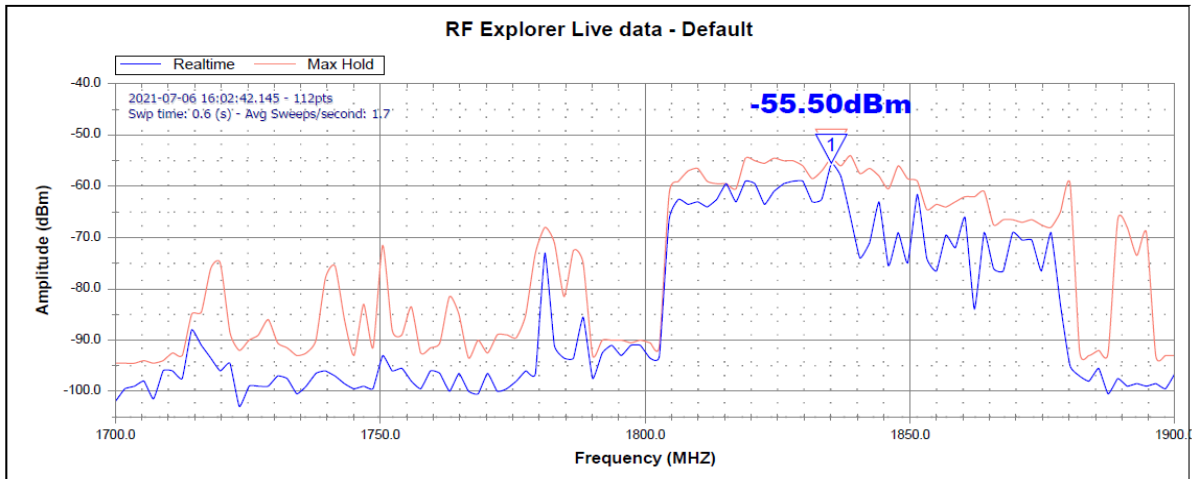

Figure 28. Spectrum Trace with TRX ON

**Tests with TRX Direct Connection to Spectrum Analyzer
Transceiver OFF**

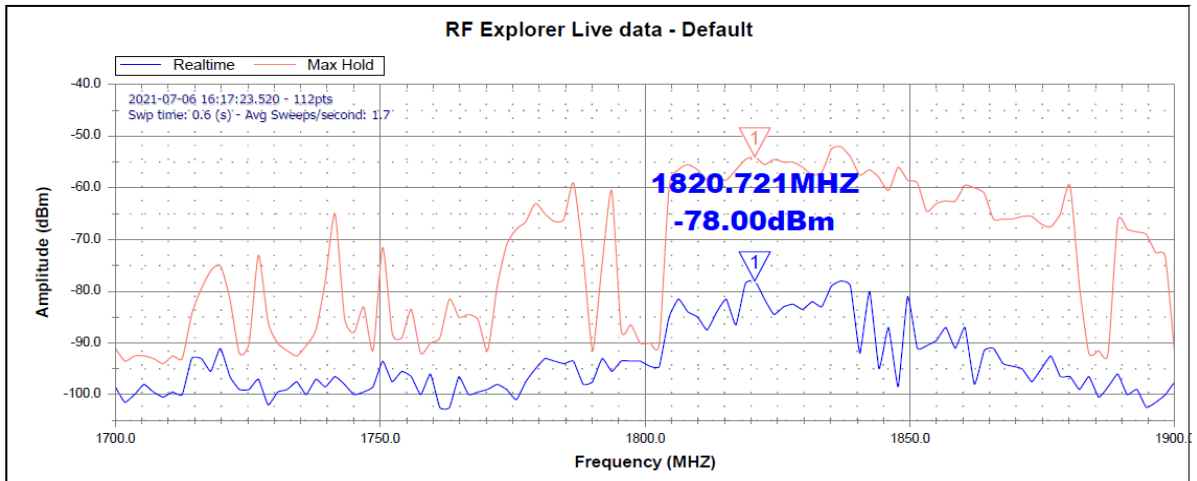

Figure 29. Direct Connection to Spectrum Analyzer with TRX OFF

**Transceiver ON
Directly connected to the spectrum analyzer**

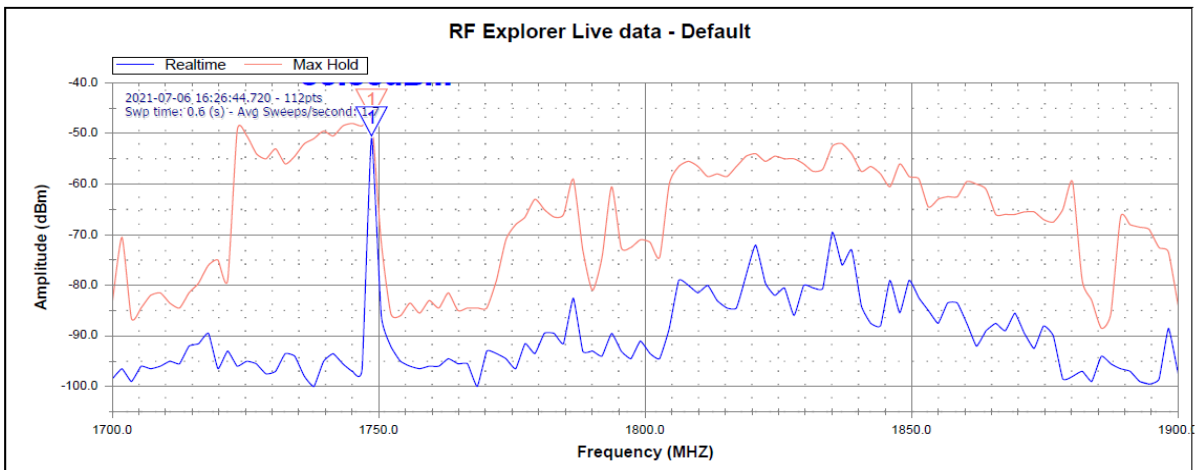

Figure 30. Direct Connection to Spectrum Analyzer with TRX OFF

Transceiver Add on Board tests

1. Transceiver Connected to a signal generator set at 1750MHz with the Add On Board OFF

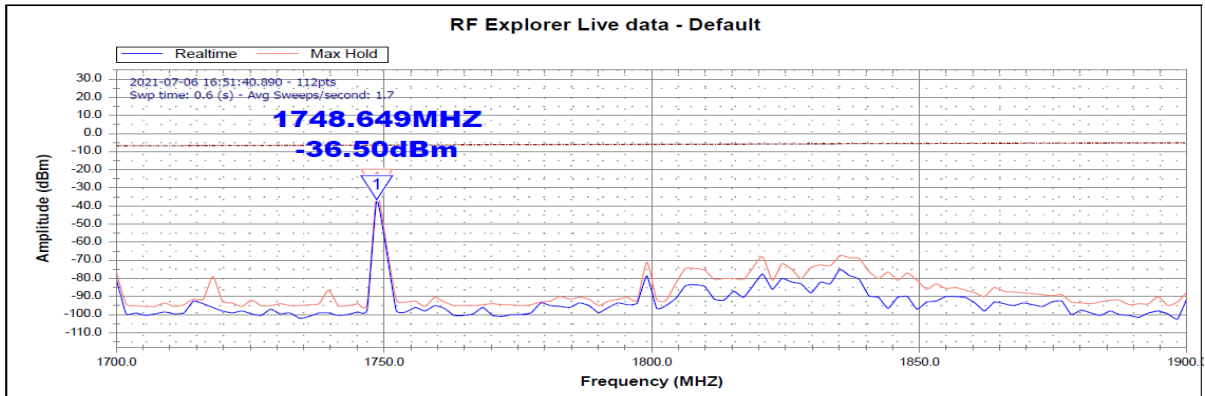

Figure 31. Add-On Board test with Signal generator set to 1750MHz and Board OFF.

2. Transceiver Connected to a signal generator with signal varied from 1700MHz -1780MHz with the Add On Board turned ON

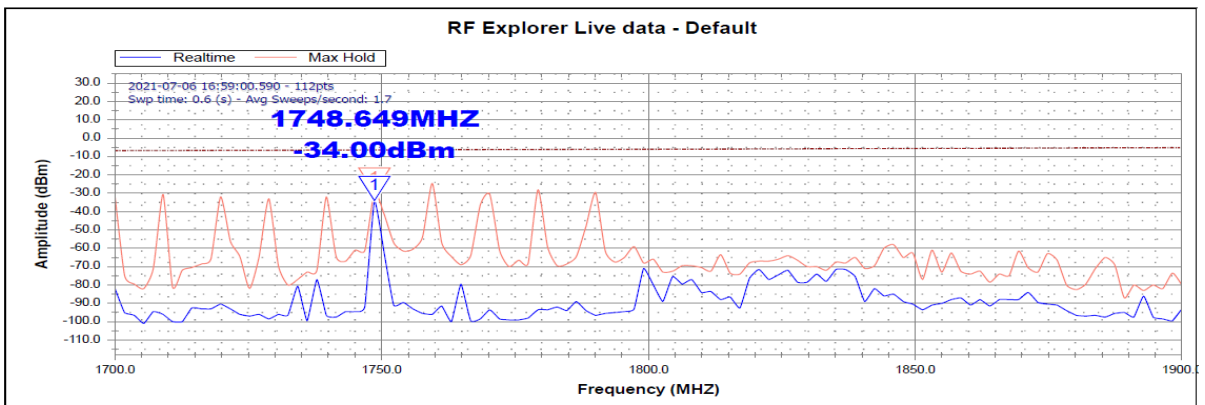

Figure 32. Add-On Board test with Signal generator varied from 1700MHz to 1780MHz with Add-On Board ON

2. Transceiver Connected to a signal generator with signal varied from 1700MHz -1900MHz with the Add On Board turned ON

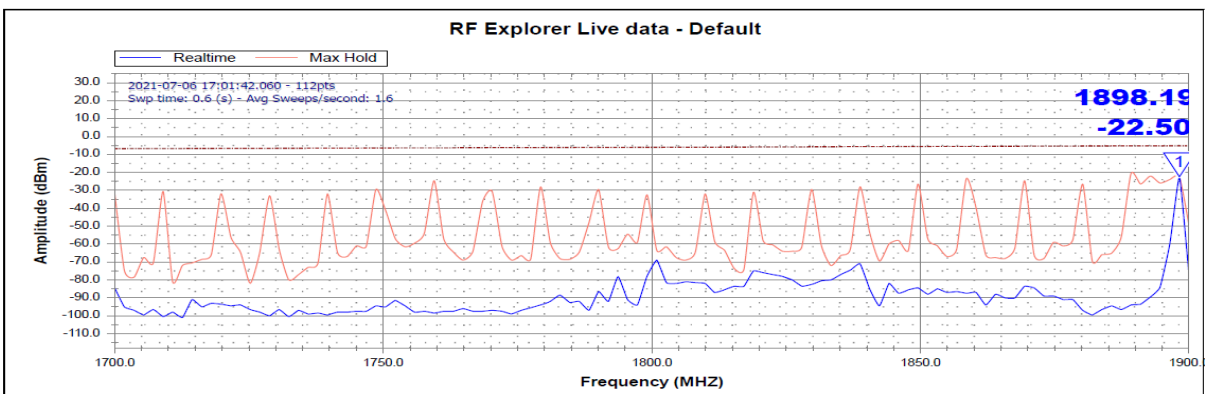

Figure 33. Add-On Board test with Signal generator varied from 1700MHz to 1900MHz with Add-On Board ON

Transceiver with Add-On Board Test
Average Transceiver Frequency Response
Transceiver OFF

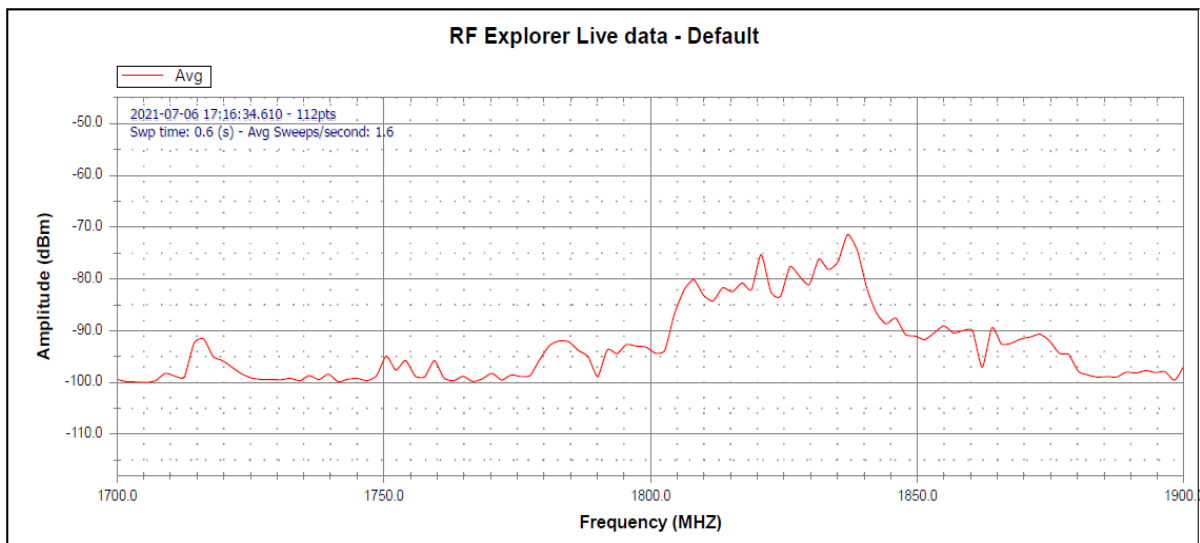

Figure 34. Average frequency response test with TRX OFF

Average Transceiver Frequency Response
Spectrum Directly connected to the TRX.
Transceiver OFF (MAX Hold is for when the TRX is ON)

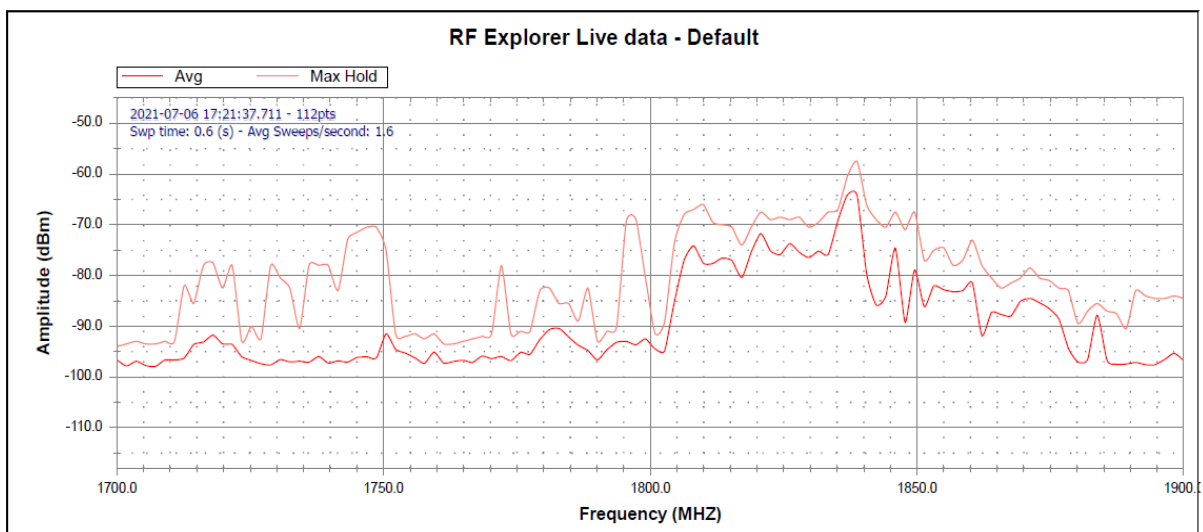

Figure 35. Average frequency response test with TRX OFF

Chapter Four

ANALYSIS AND DISCUSSION OF RESULTS

4.1 Pathloss computation

The general equation for determining pathloss is given below.

$$\text{Pathloss (d)} = \text{Pathloss (d}_0) + 10n\text{Log}(d/d_0)$$

Where n is the pathloss exponent. This is a parameter that determines the rate of signal attenuation in any given environment type. The distance between transmitter and receiver is d and d₀ is the reference point at 1 Km. Table 17 shows the pathloss exponent for different environment types. Path loss is usually expressed in dB.

Table 17. Pathloss coefficient for different environments [16 – 20]

Environment	Pathloss Exponent, n
Free space	2
Urban area cellular networks	2.7 to 3.5
Shadowed Urban cellular radio	3 to 5
In building line of sight	1.6 to 1.8
Obstructed in building	4 to 6
Obstructed in factories	2 to 3

There are different pathloss models used for estimating the pathloss for any given environment. The selection of the appropriate model to use is determined by the frequency of operation and the environmental characteristics.

Examples of these models include.

1. COST 231 Walfish-Ikegami Model
2. ITU Terrain Model
3. Hata Model
4. Hata- Okumura Model
5. Two Ray Ground Reflection Model
6. Free Space Pathloss model

The key assumption for rural mobile communication is that the transmission is a Line-of-Sight Transmission where the receiver has a direct communication link with the transmitter.

The pathloss coefficient in this case is 2 and the pathloss model to be used is the free space pathloss model. This model is shown below.

The power received at the receiver can be determined using the Friis equation as shown below.

$$P_r = \frac{P_t G_r G_t \lambda^2}{(4\pi d)^2}$$

Where G_t and G_r are the transmit and receive antenna gains

λ is the wavelength.

d is the distance between the transmitter and receiver.

P_t and P_r are the transmitted power and the received power, respectively.

The effective Isotropic Radiated power of the transmitter is given by the following expression.

$$EIRP = P_t G_t$$

The pathloss for the free space link is given by the expression below.

$$L_o = \left(\frac{4\pi d}{\lambda} \right)^2$$

This can be represented as

$$L_o = \left(\frac{4\pi d f_c}{c} \right)^2$$

Where $c = 3 \times 10^8$ m/s

For d in meters and f_c in GHz, the equation reduces to

$$L_o = \left(\frac{4\pi d f_c \times 1 \times 10^9}{3 \times 10^8} \right)^2$$

Taking $\log(10)$ on both sides converts the equation to the dB form as shown below.

$$L_o = 10 \log \left(\frac{4\pi d f_c \times 1 \times 10^9}{3 \times 10^8} \right)^2$$

$$L_o = 20 \log \left(\frac{4\pi \times 10}{3} \right) + 20 \log(f_c) + 20 \log(d)$$

$$L_o = 32.4 + 20 \log(f_c) + 20 \log(d)$$

But $L_o = P_t - P_r$. This reduces the equation to the form shown below.

$$P_t(dBm) - P_r(dBm) = 32.4 + 20 \log_{10}(fc) + 20 \log_{10}(d)$$

The distance can be computed from this expression by making d the subject of the formula and substituting the parameters of the system as shown below:

$$20 \log_{10}(d) = P_t(dBm) - P_r(dBm) - 32.4 - 20 \log_{10}(fc)$$

From the transceiver design, the following are the specifications of the transceiver

Table 18. Transceiver specifications

S/N	Parameter	Value
1	Transceiver Gain	20dB
2	Transceiver Maximum power output	+10dBm
3	Directional Antenna Gain	9dB
4	Omni Directional Antenna Gain	10dB
5	Cable losses are negligible due to the short length	Negligible
6	EIRP uplink ($P_t + G_t$ (Directional Amplifier))	+10dBm + 9dB = 19dBm
7	EIRP downlink ($P_t + G_t$ (Omnidirectional Amplifier))	+10dBm + 10dB = 20dBm

The transmit power and power control of the mobile units as specified by the GSM 05:05 regulations [21] is shown in Table 19.

Table 19. Mobile station transmit power.

Power class	GSM 900 Maximum output power	DCS 1800 Maximum output power	Tolerance (dB) for conditions	
			normal	extreme
1	-- -- --	1 W (30 dBm)	± 2	± 2.5
2	8 W (39 dBm)	0.25 W (24 dBm)	± 2	± 2.5
3	5 W (37 dBm)	4 W (36 dBm)	± 2	± 2.5
4	2 W (33 dBm)		± 2	± 2.5
5	0.8 W (29 dBm)		± 2	± 2.5

NOTE: The lowest power control level for all classes of GSM 900 MS is 19 (5 dBm) and for all classes of DCS 1 800 MS is 15 (0 dBm).

The power control steps for the mobile units is also shown in the tables 20 below

Table 20. Power Control Steps for GSM 900 and DCS 1800

GSM 900				DCS 1800			
Power control level	Output power (dBm)	Tolerance (dB) for conditions		Power control level	Output power (dBm)	Tolerance (dB) for conditions	
		normal	extreme			normal	extreme
0	-	--	--	29	36	± 2	± 2.5
1	-	--	--	30	34	± 3	± 4
2	39	± 2	± 2.5	31	32	± 3	± 4
3	37	± 3	± 4	0	30	± 3	± 4
4	35	± 3	± 4	1	28	± 3	± 4
5	33	± 3	± 4	2	26	± 3	± 4
6	31	± 3	± 4	3	24	± 3	± 4
7	29	± 3	± 4	4	22	± 3	± 4
8	27	± 3	± 4	5	20	± 3	± 4
9	25	± 3	± 4	6	18	± 3	± 4
10	23	± 3	± 4	7	16	± 3	± 4
11	21	± 3	± 4	8	14	± 3	± 4
12	19	± 3	± 4	9	12	± 4	± 5
13	17	± 3	± 4	10	10	± 4	± 5
14	15	± 3	± 4	11	8	± 4	± 5
15	13	± 3	± 4	12	6	± 4	± 5
16	11	± 5	± 6	13	4	± 4	± 5
17	9	± 5	± 6	14	2	± 5	± 6
18	7	± 5	± 6	15	0	± 5	± 6
19	5	± 5	± 6				

Base Transceiver Stations

For the BTS, the transmit power for both the GSM 900 and DCS 1800 are both shown below.

[21]

GSM 900

TRX power class	Maximum output power
1	320 - (<640) W
2	160 - (<320) W
3	80 - (<160) W
4	40 - (<80) W
5	20 - (<40) W
6	10 - (<20) W
7	5 - (<10) W
8	2.5 - (<5) W

DCS 1800

TRX power class	Maximum output power
1	20 - (<40) W
2	10 - (<20) W
3	5 - (<10) W
4	2.5 - (<5) W

The reference sensitivity for the BTS as also listed below.

BTS Receiver signal strength

-	for DCS 1800 class 1 or class 2 MS	:	-100 dBm
-	for DCS 1800 class 3 MS	:	-102 dBm
-	for GSM 900 small MS	:	-102 dBm
-	for other GSM 900 MS and normal BTS	:	-104 dBm
-	for GSM 900 micro BTS M1	:	-97 dBm
-	for GSM 900 micro BTS M2	:	-92 dBm
-	for GSM 900 micro BTS M3	:	-87 dBm
-	for DCS 1800 micro BTS M1	:	-102 dBm
-	for DCS 1800 micro BTS M2	:	-97 dBm
-	for DCS 1800 micro BTS M3	:	-92 dBm

The measurement of mobile phone sensitivity was conducted by Ofcom in the UK [22] and the results are shown in Table 21.

Table 21. Table Mobile Phone sensitivity tests

Band	Freq (MHz)	Ofcom Measured Handset Sensitivity in Free-Space (FS) (dBm)			GSMA Recommendations (dBm)	Ofcom Measured Handset Sensitivity with HH (dBm)			GSMA Recommendations (dBm)
		Min	Ave	Max		Min	Ave	Max	
GSM 900	900	-99	-104	-107	-103	-85(R)	-90	-98(L)	-95
GSM 1800	1800	-102	-105	-110	-104	-87(L)	-95	-102(R)	-99
3G Band 1	2100	-105	-106	-110	-106	-99(R)	-102	-104(R)	-101
3G Band 8	900	-102	-105	-107	-104	-87(L)	-94	-98(L)	-96
4G Band 3	1800	-93	-96	-97	-94	-83(R)	-87	-90(L)	-89
4G Band 7	2600	-87	-90	-91	-94	-82L	-84	-88R	-89
4G Band 20	800	-88	-92	-95	-93.5	-80(R)	-84	-86(R)	-85

4.2 Determination of Transceiver Range

The parameters of the transceiver, BTS and mobile phone parameters are used in the determining the range of the Transceiver. The free space pathloss model was also used as this provided the maximum range for the transceiver as it is based on a line of sight transmission scheme.

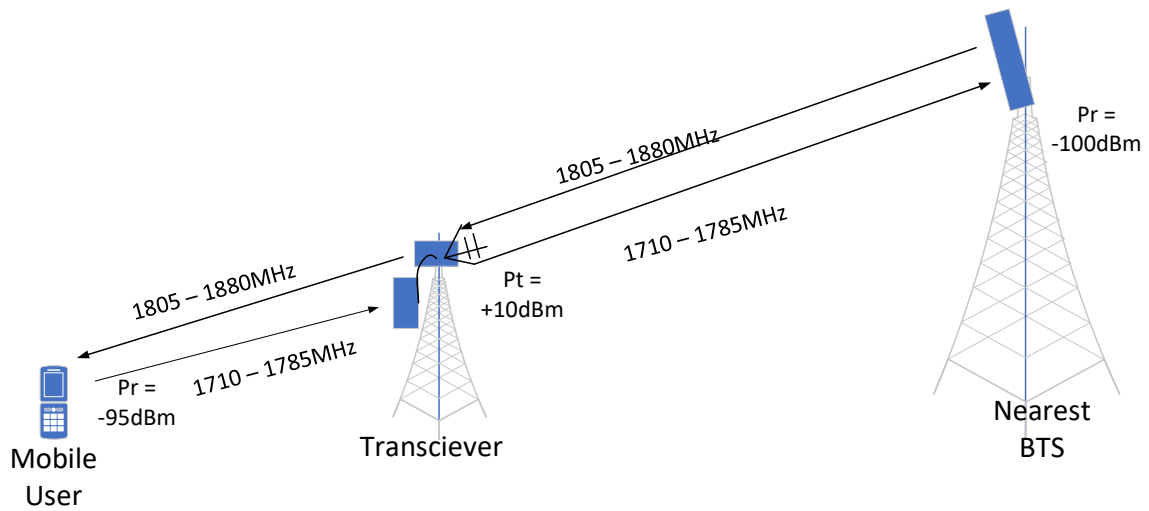

Figure 36. Transciever link diagram

From the diagram shown above, the Transmit power of the Transciever is given to be +10dBm, while the receiver power of the BTS is given to be -100dBm. The sensitivity of the mobile phone with a simulated hand and head presence is given to be -99dB. However, the test carried out by Ofcom reported in [22] shows that the value is at an average of -95dB. This was the used in the calculation.

From the free space pathloss model,

$$20 \log_{10}(d) = P_t(\text{dBm}) - P_r(\text{dBm}) - 32.4 - 20 \log_{10}(fc)$$

The value of d can be estimated from the following expression.

$$\log_{10}(d) = \frac{P_t(\text{dBm}) - P_r(\text{dBm}) - 32.4 - 20 \log_{10}(fc)}{20}$$

$$\lambda = \frac{c}{f} = \frac{3 \times 10^8}{\text{frequency}}$$

Table 22. Frequency and wavelength distribution for the uplink and downlink paths

Link		Frequency	Wavelength
BTS -TRX	Uplink	1710MHz	0.175m
		1780MHz	0.168m
	Downlink	1805MHz	0.166m
		1880MHz	0.160m
BTX – Rural User	Uplink	1710MHz	0.175m
		1780MHz	0.168m

	Downlink	1805MHz	0.166m
		1880MHz	0.160m

Substituting the values, the range of the TRX link to the nearest BTS is computed below.

$$\log_{10}(d) = \frac{P_t(dBm) - P_r(dBm) - 32.4 - 20 \log_{10}(fc)}{20}$$

$$\log_{10}(d) = \frac{+10dBm - (-100dBm) - 32.4 - 20 \log_{10}(1.71)}{20}$$

$$\log_{10}(d) = \frac{110 - 32.4 - 4.66}{20} = \frac{72.94}{20} = 3.65$$

$$d = 10^{3.65} = 4466.8 \text{ meters} = 4.5Km$$

The range the TRX can transmit to in the direction of the nearest BTS is 4.5Km

Determining the range of the TRX to Rural User, we adopt the same equations used above.

Using the sensitivity of the mobile station given to be -95dBm [22],

$$\log_{10}(d) = \frac{P_t(dBm) - P_r(dBm) - 32.4 - 20 \log_{10}(fc)}{20}$$

$$\log_{10}(d) = \frac{+10dBm - (-95dBm) - 32.4 - 20 \log_{10}(1.805)}{20}$$

$$\log_{10}(d) = \frac{105 - 32.4 - 5.13}{20} = \frac{67.47}{20} = 3.37$$

$$d = 10^{3.37} = 2344.2 \text{ meters} = 2.34km$$

The coverage range of the transceiver in the rural area assuming a line-of-sight link is 2.34km

These values are determined with the gain of both the Transmit and the Receive Antenna taken to be unity. This is because the different antennas with various gain values and towers of different heights can be used in the implementation of the system to enable the attainment of the desired range.

4.3 Discussion

The transceiver design utilized the free space pathloss which is based on the premise that the deployments will operate in a line-of-sight mode. This approach is used to determine the maximum theoretical range of the transceiver. However, for deployment in both rural and urban

communities, the impact of other attenuation parameters such as absorption, reflection and deflection and the impact of buildings and vegetation will further reduce the distance of the transceiver coverage. Analysis considered on the transmissions from the Transceiver to the BTS because with the transceiver being of lower power when compared with the BTS, it will determine the range of the link since this links are bidirectional links,

The modular approach was utilized for the design of the transceiver such that the transmit power can be increased by the addition of more modules to the transceiver board. The transceiver showed a frequency response that covered the entire GSM band making it suitable for deployment across networks and suitable for deployment both in the urban and the rural areas. The low power consumption of the board also ensures the transceiver can be powered by solar panels making a cost-effective solution suitable for remote locations without access to grid power supply.

4.4 Capacity Building Benefits of the project

The project enabled the training of students in the design and development of communication infrastructure. The spectrum analyzer was used in the Communication principles class to showcase the frequency spectrum to the student. Graduate students are also being trained on the use of the spectrum analyzer for frequency monitoring and drive testing. Students were also exposed to communication equipment design through the instrumentality of the prototype. The project is contributing to the development of local capacity on communication equipment design which is a very critical skill required to enable local content development in the field of communication infrastructure design and development.

4.5 Relevance to the Telecommunications Industry

The project impacts on the telecommunications industry from the setting up phase of the network to the operation phase of the network. Its impact is listed below

1. Reduction in cost of setting up Communication Networks: Base Transceiver stations cell sites have been reported to cost as much a \$1Million per site to setup. This cost is largely due to the fact that the entire base station components are imported and the design is not optimized for the power supply conditions in the country. This transceiver will impact the telecommunications industry in terms of the required CAPEX for setting up the cell sites as its design and possible manufacture in the country will eliminate the need to import

transceiver cards either for the setting up of new base stations or the replacement of failed cards.

2. Development of skilled manpower for the design of communication infrastructure: The project will enable the development of the required skills for the design of different communication infrastructure. It will also enable the development of other communication components for the GSM communication network and newer communication technologies.
3. Rapid rollout of communications technology: The ability to build communication infrastructure in the country will enable the rapid roll out of new communication technologies designed to suit our local environment and conditions.
4. Reduction in OPEX cost for base stations. The low-cost power consumption the transceiver will enable the use of solar panels or other renewable energy supply source for the operation of the base stations resulting in low OPEX cost
5. Rural Mobile Communication: The architecture will enable the development of rural mobile communication as it provides a low cost scalable communication architecture that can be run on solar panels. This will provide the required incentives for operators to deploy communication services to rural areas without the huge overhead cost of generators and also a reduced cooling requirement of the different transceiver cards

Chapter Five

CONCLUSIONS AND RECOMMENDATION

5.1 Conclusion

The need to build capacity in the areas of system design and manufacture continues to remain a critical requirement for any nation that desires technological breakthrough. Hardware projects rely on a suite of services ranging from the design, the development of the appropriate drawing and files for Printed circuit manufacture, the procurement of the components and the actual manufacture and testing of the prototype. All these service require the engagement of multiple skills and competences and the reliance of third-party for the delivery of these services. These reliance on third party has the capacity to either derail, delay or even stop the project.

These were all experienced in the execution of this project. The impact of the COVID lock downs further amplified the impact of the third-party organizations engaged for specific purposes required for the completion of the project. The next section discusses mitigation factors and strategies that can be employed to ensure that the impact of these third-party organizations do not cause the project to fail.

The project was able to accomplish its target, and a low-cost bidirectional transceiver prototype was produced and tested, with positive results. However, the original design was for the development of a network agnostic transceiver system but the changes in component availability led to the design of the transceiver system which is tuned to the 9Mobile network.

5.2 Recommendation

The following are recommendations which can reduce the impact of third parties on the execution of project.

1. Principal Investigators (PI) and researchers should invest in acquiring as much of the critical skills as possible. This will minimize the reliance on third parties for the execution of critical sections of the project.
2. The PI and the commission should agree on the project work breakdown structure to ensure that funds are released early enough for the critical components and equipment required for the execution of the project. Early release of the funds will shield the research from the fluctuations in the foreign exchange in the case that the researcher needs to procure equipment from abroad.

3. There is a need for a deliberate investment in prototyping capabilities in country. This will enable researchers test out the variation in their designs as quickly as possible.
4. Researchers should ensure that the budget is realistic to capture all possible costs that will be associated with the project all through the lifespan of the project.
5. Research equipment should be given some duty fee exemption status as this will reduce the project costs and eliminate delays when the equipment gets into the country. This project experienced some delays when it arrived in the country and this was because the Customs office required the payment of import duty.
6. The funds allocation for each stage of the work should be discussed with the PI and agreed before funds are to be released. This meeting is necessary so that the project plan and the release of funds are aligned to avoid project delays due to lack of funding.

References

- [1] Lori A. Dickes, R. David Lamie, and Brian E. Whitacre . The Struggle for Broadband in Rural America .Agricultural & Applied Economics Association 4th Quarter 2010 | 25(4)
- [2] Peter Bell, Pavani Reddy and Lee Rainie, Rural Areas and the Internet . PEW INTERNET & AMERICAN LIFE PROJECT February 17 2004
- [3] Rural infrastructure in Africa: Unlocking the African Moment. Development Support Monitor. Paper Series No1, 2012 African Monitor.
- [4] Digital Dividends: Overview. World Development Report 2016 (102724). World Bank Group 2016
- [5] Arturo Muento-Kunigami and Juan Navas-Sabater. Options to Increase Access to Telecommunications Services in Rural and Low-Income Areas. World Bank Working Paper No 178. World Bank Group 2010
- [6] Imme Philbeck. CONNECTING THE UNCONNECTED Working together to achieve Connect 2020 Agenda Targets. ITU discussion paper. World Economic Forum. Davos Annual Meeting 2017
- [7] Building a Digital Nigeria. An Economist Intelligence Unit Report 2016
- [8] Chinecherem Umezuruike, Awodele Oludele, Kuyoro S. O., Izang Aaron A. Broadband Internet Penetration in Nigeria: A Review. International Journal of Research Studies in Computer Science and Engineering (IJRSCSE). Volume 2, Issue 1, January 2015, PP 1-7
- [9] Y.A Adediran, N. Faruk, J.F Opadiji and O.W Bello. On Issues and Challenges of Rural Telecommunication Access in Nigeria. African Journal of Education, Science and Technology, April, 2016 Vol 3, No. 2
- [10] Understanding GSM/EDGE Transmitter and Receiver measurements for Base Transceiver Station and their components. Application Note 1312. Agilent Technologies 2002
- [11] P. Kimuli Introduction to GSM and GSM Mobile RF Transceiver derivations. RF Embedded System Design June 2003.
- [12] P. Rakers, D.B Schwartz, M. Rahman and J.Mittel SAW-Less Transceiver for 4G/3G/2G Cellular standard. FUJITSU Sci. Tech. Journal Vol 48 No 1 January 2012
- [13] E.Song, Y. Koo, Y. Jung, D.Lee S.Chu and S.Chae . A 0.24 μ m CMOS Quad-Band GSM RF Transceiver using Efficient LO Frequency plan. IEEE Journal of Solid State Circuits Vol 40 No 5 May 2005
- [14] Idachaba F.E and Edeko F.O. Analysis and Development of a low cost GSM Telephone system for a rural area. Global Journal of Engineering and Technology. Vol 4, No 2, (2011) India 165-176 India 2011
- [15] Idachaba F.E Analysis and Development of a Low-cost GSM telephone system for a Rural Area. PhD Thesis University of Benin. Nigeria 2009
- [16] Andrea Goldsmiths. Wireless communications. Cambridge University Press. 2005;7:43-67.
- [17] Lichun L. IEEE Ant. Prop. Magazine. 2000;21-33.
- [18] Longley AG. "Radio Propagation in Urban Area" OT Report New York, pp 78-144. Propagation. 1998;42(2):137-144.
- [19] Schaubach KR, Davis IV, Rappaport TS. A ray tracing method for predicting path loss.

- and delay spread in microcellular environments. *IEEE Veh. Trans. Tech.* 1992;932-935.
- [20] Seidel SY, Rappaport TS. 914MHz Path Loss Prediction Models for Indoor Wireless Communications in Multifloored Buildings. *IEEE Transactions on Antennas and Propagation.* 1992;40(2):207-217.
- [21] Digital cellular telecommunications system (Phase 2+); Radio transmission and reception. (GSM 05.05). ETSI
- [22] Mobile Handset Testing. A REPORT FOR OFCOM, THE UK COMMUNICATION REGULATOR. November 2015

Appendix A

Uplink and Downlink frequency allocation for GSM operators

Operator	n	Channel Number	Channel bandwidth (0.2MHz)	Uplink Frequencies (MHz)	Downlink frequencies (MHz)
NTEL	512	1	0.2	1710.2	1805.2
	513	2	0.2	1710.4	1805.4
	514	3	0.2	1710.6	1805.6
	515	4	0.2	1710.8	1805.8
	516	5	0.2	1711	1806
	517	6	0.2	1711.2	1806.2
	518	7	0.2	1711.4	1806.4
	519	8	0.2	1711.6	1806.6
	520	9	0.2	1711.8	1806.8
	521	10	0.2	1712	1807
	522	11	0.2	1712.2	1807.2
	523	12	0.2	1712.4	1807.4
	524	13	0.2	1712.6	1807.6
	525	14	0.2	1712.8	1807.8
	526	15	0.2	1713	1808
	527	16	0.2	1713.2	1808.2
	528	17	0.2	1713.4	1808.4
	529	18	0.2	1713.6	1808.6
	530	19	0.2	1713.8	1808.8
	531	20	0.2	1714	1809
	532	21	0.2	1714.2	1809.2
	533	22	0.2	1714.4	1809.4
	534	23	0.2	1714.6	1809.6
	535	24	0.2	1714.8	1809.8
	536	25	0.2	1715	1810
	537	26	0.2	1715.2	1810.2
	538	27	0.2	1715.4	1810.4
	539	28	0.2	1715.6	1810.6
	540	29	0.2	1715.8	1810.8
	541	30	0.2	1716	1811
	542	31	0.2	1716.2	1811.2
	543	32	0.2	1716.4	1811.4
	544	33	0.2	1716.6	1811.6
	545	34	0.2	1716.8	1811.8
	546	35	0.2	1717	1812
	547	36	0.2	1717.2	1812.2
	548	37	0.2	1717.4	1812.4
	549	38	0.2	1717.6	1812.6
	550	39	0.2	1717.8	1812.8
	551	40	0.2	1718	1813
	552	41	0.2	1718.2	1813.2
	553	42	0.2	1718.4	1813.4
	554	43	0.2	1718.6	1813.6
	555	44	0.2	1718.8	1813.8
	556	45	0.2	1719	1814
	557	46	0.2	1719.2	1814.2
	558	47	0.2	1719.4	1814.4
	559	48	0.2	1719.6	1814.6
	560	49	0.2	1719.8	1814.8
	561	50	0.2	1720	1815
	562	51	0.2	1720.2	1815.2
	563	52	0.2	1720.4	1815.4
	564	53	0.2	1720.6	1815.6

	565	54	0.2	1720.8	1815.8
	566	55	0.2	1721	1816
	567	56	0.2	1721.2	1816.2
	568	57	0.2	1721.4	1816.4
	569	58	0.2	1721.6	1816.6
	570	59	0.2	1721.8	1816.8
	571	60	0.2	1722	1817
	572	61	0.2	1722.2	1817.2
	573	62	0.2	1722.4	1817.4
	574	63	0.2	1722.6	1817.6
	575	64	0.2	1722.8	1817.8
	576	65	0.2	1723	1818
	577	66	0.2	1723.2	1818.2
	578	67	0.2	1723.4	1818.4
	579	68	0.2	1723.6	1818.6
	580	69	0.2	1723.8	1818.8
	581	70	0.2	1724	1819
	582	71	0.2	1724.2	1819.2
	583	72	0.2	1724.4	1819.4
	584	73	0.2	1724.6	1819.6
	585	74	0.2	1724.8	1819.8
	586	75	0.2	1725	1820
Operator	n	Channel Number	Channel bandwidth (0.2MHz)	Uplink Frequencies (MHz)	Downlink frequencies (MHz)
Globacom	587	76	0.2	1725.2	1820.2
	588	77	0.2	1725.4	1820.4
	589	78	0.2	1725.6	1820.6
	590	79	0.2	1725.8	1820.8
	591	80	0.2	1726	1821
	592	81	0.2	1726.2	1821.2
	593	82	0.2	1726.4	1821.4
	594	83	0.2	1726.6	1821.6
	595	84	0.2	1726.8	1821.8
	596	85	0.2	1727	1822
	597	86	0.2	1727.2	1822.2
	598	87	0.2	1727.4	1822.4
	599	88	0.2	1727.6	1822.6
	600	89	0.2	1727.8	1822.8
	601	90	0.2	1728	1823
	602	91	0.2	1728.2	1823.2
	603	92	0.2	1728.4	1823.4
	604	93	0.2	1728.6	1823.6
	605	94	0.2	1728.8	1823.8
	606	95	0.2	1729	1824
	607	96	0.2	1729.2	1824.2
	608	97	0.2	1729.4	1824.4
	609	98	0.2	1729.6	1824.6
	610	99	0.2	1729.8	1824.8
	611	100	0.2	1730	1825
	612	101	0.2	1730.2	1825.2
	613	102	0.2	1730.4	1825.4
	614	103	0.2	1730.6	1825.6
	615	104	0.2	1730.8	1825.8
	616	105	0.2	1731	1826
	617	106	0.2	1731.2	1826.2
	618	107	0.2	1731.4	1826.4
	619	108	0.2	1731.6	1826.6
	620	109	0.2	1731.8	1826.8

	621	110	0.2	1732	1827
	622	111	0.2	1732.2	1827.2
	623	112	0.2	1732.4	1827.4
	624	113	0.2	1732.6	1827.6
	625	114	0.2	1732.8	1827.8
	626	115	0.2	1733	1828
	627	116	0.2	1733.2	1828.2
	628	117	0.2	1733.4	1828.4
	629	118	0.2	1733.6	1828.6
	630	119	0.2	1733.8	1828.8
	631	120	0.2	1734	1829
	632	121	0.2	1734.2	1829.2
	633	122	0.2	1734.4	1829.4
	634	123	0.2	1734.6	1829.6
	635	124	0.2	1734.8	1829.8
	636	125	0.2	1735	1830
	637	126	0.2	1735.2	1830.2
	638	127	0.2	1735.4	1830.4
	639	128	0.2	1735.6	1830.6
	640	129	0.2	1735.8	1830.8
	641	130	0.2	1736	1831
	642	131	0.2	1736.2	1831.2
	643	132	0.2	1736.4	1831.4
	644	133	0.2	1736.6	1831.6
	645	134	0.2	1736.8	1831.8
	646	135	0.2	1737	1832
	647	136	0.2	1737.2	1832.2
	648	137	0.2	1737.4	1832.4
	649	138	0.2	1737.6	1832.6
	650	139	0.2	1737.8	1832.8
	651	140	0.2	1738	1833
	652	141	0.2	1738.2	1833.2
	653	142	0.2	1738.4	1833.4
	654	143	0.2	1738.6	1833.6
	655	144	0.2	1738.8	1833.8
	656	145	0.2	1739	1834
	657	146	0.2	1739.2	1834.2
	658	147	0.2	1739.4	1834.4
	659	148	0.2	1739.6	1834.6
	660	149	0.2	1739.8	1834.8
	661	150	0.2	1740	1835
Operator	n	Channel Number	Channel bandwidth (0.2MHz)	Uplink Frequencies (MHz)	Downlink frequencies (MHz)
MTN	662	151	0.2	1740.2	1835.2
	663	152	0.2	1740.4	1835.4
	664	153	0.2	1740.6	1835.6
	665	154	0.2	1740.8	1835.8
	666	155	0.2	1741	1836
	667	156	0.2	1741.2	1836.2
	668	157	0.2	1741.4	1836.4
	669	158	0.2	1741.6	1836.6
	670	159	0.2	1741.8	1836.8
	671	160	0.2	1742	1837
	672	161	0.2	1742.2	1837.2
	673	162	0.2	1742.4	1837.4
	674	163	0.2	1742.6	1837.6
	675	164	0.2	1742.8	1837.8
	676	165	0.2	1743	1838

677	166	0.2	1743.2	1838.2
678	167	0.2	1743.4	1838.4
679	168	0.2	1743.6	1838.6
680	169	0.2	1743.8	1838.8
681	170	0.2	1744	1839
682	171	0.2	1744.2	1839.2
683	172	0.2	1744.4	1839.4
684	173	0.2	1744.6	1839.6
685	174	0.2	1744.8	1839.8
686	175	0.2	1745	1840
687	176	0.2	1745.2	1840.2
688	177	0.2	1745.4	1840.4
689	178	0.2	1745.6	1840.6
690	179	0.2	1745.8	1840.8
691	180	0.2	1746	1841
692	181	0.2	1746.2	1841.2
693	182	0.2	1746.4	1841.4
694	183	0.2	1746.6	1841.6
695	184	0.2	1746.8	1841.8
696	185	0.2	1747	1842
697	186	0.2	1747.2	1842.2
698	187	0.2	1747.4	1842.4
699	188	0.2	1747.6	1842.6
700	189	0.2	1747.8	1842.8
701	190	0.2	1748	1843
702	191	0.2	1748.2	1843.2
703	192	0.2	1748.4	1843.4
704	193	0.2	1748.6	1843.6
705	194	0.2	1748.8	1843.8
706	195	0.2	1749	1844
707	196	0.2	1749.2	1844.2
708	197	0.2	1749.4	1844.4
709	198	0.2	1749.6	1844.6
710	199	0.2	1749.8	1844.8
711	200	0.2	1750	1845
712	201	0.2	1750.2	1845.2
713	202	0.2	1750.4	1845.4
714	203	0.2	1750.6	1845.6
715	204	0.2	1750.8	1845.8
716	205	0.2	1751	1846
717	206	0.2	1751.2	1846.2
718	207	0.2	1751.4	1846.4
719	208	0.2	1751.6	1846.6
720	209	0.2	1751.8	1846.8
721	210	0.2	1752	1847
722	211	0.2	1752.2	1847.2
723	212	0.2	1752.4	1847.4
724	213	0.2	1752.6	1847.6
725	214	0.2	1752.8	1847.8
726	215	0.2	1753	1848
727	216	0.2	1753.2	1848.2
728	217	0.2	1753.4	1848.4
729	218	0.2	1753.6	1848.6
730	219	0.2	1753.8	1848.8
731	220	0.2	1754	1849
732	221	0.2	1754.2	1849.2
733	222	0.2	1754.4	1849.4
734	223	0.2	1754.6	1849.6

	735	224	0.2	1754.8	1849.8
	736	225	0.2	1755	1850
Operator	n	Channel Number	Channel bandwidth (0.2MHz)	Uplink Frequencies (MHz)	Downlink frequencies (MHz)
AIRTEL	737	226	0.2	1755.2	1850.2
	738	227	0.2	1755.4	1850.4
	739	228	0.2	1755.6	1850.6
	740	229	0.2	1755.8	1850.8
	741	230	0.2	1756	1851
	742	231	0.2	1756.2	1851.2
	743	232	0.2	1756.4	1851.4
	744	233	0.2	1756.6	1851.6
	745	234	0.2	1756.8	1851.8
	746	235	0.2	1757	1852
	747	236	0.2	1757.2	1852.2
	748	237	0.2	1757.4	1852.4
	749	238	0.2	1757.6	1852.6
	750	239	0.2	1757.8	1852.8
	751	240	0.2	1758	1853
	752	241	0.2	1758.2	1853.2
	753	242	0.2	1758.4	1853.4
	754	243	0.2	1758.6	1853.6
	755	244	0.2	1758.8	1853.8
	756	245	0.2	1759	1854
	757	246	0.2	1759.2	1854.2
	758	247	0.2	1759.4	1854.4
	759	248	0.2	1759.6	1854.6
	760	249	0.2	1759.8	1854.8
	761	250	0.2	1760	1855
	762	251	0.2	1760.2	1855.2
	763	252	0.2	1760.4	1855.4
	764	253	0.2	1760.6	1855.6
	765	254	0.2	1760.8	1855.8
	766	255	0.2	1761	1856
	767	256	0.2	1761.2	1856.2
	768	257	0.2	1761.4	1856.4
	769	258	0.2	1761.6	1856.6
	770	259	0.2	1761.8	1856.8
	771	260	0.2	1762	1857
	772	261	0.2	1762.2	1857.2
	773	262	0.2	1762.4	1857.4
	774	263	0.2	1762.6	1857.6
	775	264	0.2	1762.8	1857.8
	776	265	0.2	1763	1858
	777	266	0.2	1763.2	1858.2
	778	267	0.2	1763.4	1858.4
	779	268	0.2	1763.6	1858.6
	780	269	0.2	1763.8	1858.8
	781	270	0.2	1764	1859
	782	271	0.2	1764.2	1859.2
	783	272	0.2	1764.4	1859.4
	784	273	0.2	1764.6	1859.6
	785	274	0.2	1764.8	1859.8
	786	275	0.2	1765	1860
	787	276	0.2	1765.2	1860.2
	788	277	0.2	1765.4	1860.4
	789	278	0.2	1765.6	1860.6
	790	279	0.2	1765.8	1860.8

	791	280	0.2	1766	1861
	792	281	0.2	1766.2	1861.2
	793	282	0.2	1766.4	1861.4
	794	283	0.2	1766.6	1861.6
	795	284	0.2	1766.8	1861.8
	796	285	0.2	1767	1862
	797	286	0.2	1767.2	1862.2
	798	287	0.2	1767.4	1862.4
	799	288	0.2	1767.6	1862.6
	800	289	0.2	1767.8	1862.8
	801	290	0.2	1768	1863
	802	291	0.2	1768.2	1863.2
	803	292	0.2	1768.4	1863.4
	804	293	0.2	1768.6	1863.6
	805	294	0.2	1768.8	1863.8
	806	295	0.2	1769	1864
	807	296	0.2	1769.2	1864.2
	808	297	0.2	1769.4	1864.4
	809	298	0.2	1769.6	1864.6
	810	299	0.2	1769.8	1864.8
	811	300	0.2	1770	1865
Operator	n	Channel Number	Channel bandwidth (0.2MHz)	Uplink Frequencies (MHz)	Downlink frequencies (MHz)
9Mobile	812	301	0.2	1770.2	1865.2
	813	302	0.2	1770.4	1865.4
	814	303	0.2	1770.6	1865.6
	815	304	0.2	1770.8	1865.8
	816	305	0.2	1771	1866
	817	306	0.2	1771.2	1866.2
	818	307	0.2	1771.4	1866.4
	819	308	0.2	1771.6	1866.6
	820	309	0.2	1771.8	1866.8
	821	310	0.2	1772	1867
	822	311	0.2	1772.2	1867.2
	823	312	0.2	1772.4	1867.4
	824	313	0.2	1772.6	1867.6
	825	314	0.2	1772.8	1867.8
	826	315	0.2	1773	1868
	827	316	0.2	1773.2	1868.2
	828	317	0.2	1773.4	1868.4
	829	318	0.2	1773.6	1868.6
	830	319	0.2	1773.8	1868.8
	831	320	0.2	1774	1869
	832	321	0.2	1774.2	1869.2
	833	322	0.2	1774.4	1869.4
	834	323	0.2	1774.6	1869.6
	835	324	0.2	1774.8	1869.8
	836	325	0.2	1775	1870
	837	326	0.2	1775.2	1870.2
	838	327	0.2	1775.4	1870.4
	839	328	0.2	1775.6	1870.6
	840	329	0.2	1775.8	1870.8
	841	330	0.2	1776	1871
	842	331	0.2	1776.2	1871.2
	843	332	0.2	1776.4	1871.4
	844	333	0.2	1776.6	1871.6
	845	334	0.2	1776.8	1871.8
	846	335	0.2	1777	1872

847	336	0.2	1777.2	1872.2
848	337	0.2	1777.4	1872.4
849	338	0.2	1777.6	1872.6
850	339	0.2	1777.8	1872.8
851	340	0.2	1778	1873
852	341	0.2	1778.2	1873.2
853	342	0.2	1778.4	1873.4
854	343	0.2	1778.6	1873.6
855	344	0.2	1778.8	1873.8
856	345	0.2	1779	1874
857	346	0.2	1779.2	1874.2
858	347	0.2	1779.4	1874.4
859	348	0.2	1779.6	1874.6
860	349	0.2	1779.8	1874.8
861	350	0.2	1780	1875
862	351	0.2	1780.2	1875.2
863	352	0.2	1780.4	1875.4
864	353	0.2	1780.6	1875.6
865	354	0.2	1780.8	1875.8
866	355	0.2	1781	1876
867	356	0.2	1781.2	1876.2
868	357	0.2	1781.4	1876.4
869	358	0.2	1781.6	1876.6
870	359	0.2	1781.8	1876.8
871	360	0.2	1782	1877
872	361	0.2	1782.2	1877.2
873	362	0.2	1782.4	1877.4
874	363	0.2	1782.6	1877.6
875	364	0.2	1782.8	1877.8
876	365	0.2	1783	1878
877	366	0.2	1783.2	1878.2
878	367	0.2	1783.4	1878.4
879	368	0.2	1783.6	1878.6
880	369	0.2	1783.8	1878.8
881	370	0.2	1784	1879
882	371	0.2	1784.2	1879.2
883	372	0.2	1784.4	1879.4
884	373	0.2	1784.6	1879.6
885	374	0.2	1784.8	1879.8

Appendix B

Intermediate Frequency and Mixer selection analysis for Uplink band

Uplink Frequencies 1710 - 1785													
	BPF (1747.5) Uplink					Mixer Input		Mixer Output		IF Filter Band (MHz) (VCO fixed at 1520)			
Operator	Min	Max	Channel Number	Channel bandwidth (MHz)	Channels	min	max	Min (1520)	max (1595)	Min	Max	IF B/W	IF Center freq
NTEL	1710	1785	1	0.2	1710.2	1520	1595	190.2	115.2	190.2	205	14.8	197.6
	1710	1785	2	0.2	1710.4	1520	1595	190.4	115.4				
	1710	1785	3	0.2	1710.6	1520	1595	190.6	115.6				
	1710	1785	4	0.2	1710.8	1520	1595	190.8	115.8				
	1710	1785	5	0.2	1711	1520	1595	191	116				
	1710	1785	6	0.2	1711.2	1520	1595	191.2	116.2				
	1710	1785	7	0.2	1711.4	1520	1595	191.4	116.4				
	1710	1785	8	0.2	1711.6	1520	1595	191.6	116.6				
	1710	1785	9	0.2	1711.8	1520	1595	191.8	116.8				
	1710	1785	10	0.2	1712	1520	1595	192	117				
	1710	1785	11	0.2	1712.2	1520	1595	192.2	117.2				
	1710	1785	12	0.2	1712.4	1520	1595	192.4	117.4				
	1710	1785	13	0.2	1712.6	1520	1595	192.6	117.6				
	1710	1785	14	0.2	1712.8	1520	1595	192.8	117.8				
	1710	1785	15	0.2	1713	1520	1595	193	118				
	1710	1785	16	0.2	1713.2	1520	1595	193.2	118.2				
	1710	1785	17	0.2	1713.4	1520	1595	193.4	118.4				
	1710	1785	18	0.2	1713.6	1520	1595	193.6	118.6				
	1710	1785	19	0.2	1713.8	1520	1595	193.8	118.8				
	1710	1785	20	0.2	1714	1520	1595	194	119				
	1710	1785	21	0.2	1714.2	1520	1595	194.2	119.2				
	1710	1785	22	0.2	1714.4	1520	1595	194.4	119.4				
	1710	1785	23	0.2	1714.6	1520	1595	194.6	119.6				

1710	1785	24	0.2	1714.8	1520	1595	194.8	119.8		
1710	1785	25	0.2	1715	1520	1595	195	120		
1710	1785	26	0.2	1715.2	1520	1595	195.2	120.2		
1710	1785	27	0.2	1715.4	1520	1595	195.4	120.4		
1710	1785	28	0.2	1715.6	1520	1595	195.6	120.6		
1710	1785	29	0.2	1715.8	1520	1595	195.8	120.8		
1710	1785	30	0.2	1716	1520	1595	196	121		
1710	1785	31	0.2	1716.2	1520	1595	196.2	121.2		
1710	1785	32	0.2	1716.4	1520	1595	196.4	121.4		
1710	1785	33	0.2	1716.6	1520	1595	196.6	121.6		
1710	1785	34	0.2	1716.8	1520	1595	196.8	121.8		
1710	1785	35	0.2	1717	1520	1595	197	122		
1710	1785	36	0.2	1717.2	1520	1595	197.2	122.2		
1710	1785	37	0.2	1717.4	1520	1595	197.4	122.4		
1710	1785	38	0.2	1717.6	1520	1595	197.6	122.6		
1710	1785	39	0.2	1717.8	1520	1595	197.8	122.8		
1710	1785	40	0.2	1718	1520	1595	198	123		
1710	1785	41	0.2	1718.2	1520	1595	198.2	123.2		
1710	1785	42	0.2	1718.4	1520	1595	198.4	123.4		
1710	1785	43	0.2	1718.6	1520	1595	198.6	123.6		
1710	1785	44	0.2	1718.8	1520	1595	198.8	123.8		
1710	1785	45	0.2	1719	1520	1595	199	124		
1710	1785	46	0.2	1719.2	1520	1595	199.2	124.2		
1710	1785	47	0.2	1719.4	1520	1595	199.4	124.4		
1710	1785	48	0.2	1719.6	1520	1595	199.6	124.6		
1710	1785	49	0.2	1719.8	1520	1595	199.8	124.8		
1710	1785	50	0.2	1720	1520	1595	200	125		
1710	1785	51	0.2	1720.2	1520	1595	200.2	125.2		
1710	1785	52	0.2	1720.4	1520	1595	200.4	125.4		

	1710	1785	53	0.2	1720.6	1520	1595	200.6	125.6				
	1710	1785	54	0.2	1720.8	1520	1595	200.8	125.8				
	1710	1785	55	0.2	1721	1520	1595	201	126				
	1710	1785	56	0.2	1721.2	1520	1595	201.2	126.2				
	1710	1785	57	0.2	1721.4	1520	1595	201.4	126.4				
	1710	1785	58	0.2	1721.6	1520	1595	201.6	126.6				
	1710	1785	59	0.2	1721.8	1520	1595	201.8	126.8				
	1710	1785	60	0.2	1722	1520	1595	202	127				
	1710	1785	61	0.2	1722.2	1520	1595	202.2	127.2				
	1710	1785	62	0.2	1722.4	1520	1595	202.4	127.4				
	1710	1785	63	0.2	1722.6	1520	1595	202.6	127.6				
	1710	1785	64	0.2	1722.8	1520	1595	202.8	127.8				
	1710	1785	65	0.2	1723	1520	1595	203	128				
	1710	1785	66	0.2	1723.2	1520	1595	203.2	128.2				
	1710	1785	67	0.2	1723.4	1520	1595	203.4	128.4				
	1710	1785	68	0.2	1723.6	1520	1595	203.6	128.6				
	1710	1785	69	0.2	1723.8	1520	1595	203.8	128.8				
	1710	1785	70	0.2	1724	1520	1595	204	129				
	1710	1785	71	0.2	1724.2	1520	1595	204.2	129.2				
	1710	1785	72	0.2	1724.4	1520	1595	204.4	129.4				
	1710	1785	73	0.2	1724.6	1520	1595	204.6	129.6				
	1710	1785	74	0.2	1724.8	1520	1595	204.8	129.8				
	1710	1785	75	0.2	1725	1520	1595	205	130				
Globacom	1710	1785	76	0.2	1725.2	1520	1595	205.2	130.2	205.2	220	14.8	212.6
	1710	1785	77	0.2	1725.4	1520	1595	205.4	130.4				
	1710	1785	78	0.2	1725.6	1520	1595	205.6	130.6				
	1710	1785	79	0.2	1725.8	1520	1595	205.8	130.8				
	1710	1785	80	0.2	1726	1520	1595	206	131				
	1710	1785	81	0.2	1726.2	1520	1595	206.2	131.2				

1710	1785	82	0.2	1726.4	1520	1595	206.4	131.4				
1710	1785	83	0.2	1726.6	1520	1595	206.6	131.6				
1710	1785	84	0.2	1726.8	1520	1595	206.8	131.8				
1710	1785	85	0.2	1727	1520	1595	207	132				
1710	1785	86	0.2	1727.2	1520	1595	207.2	132.2				
1710	1785	87	0.2	1727.4	1520	1595	207.4	132.4				
1710	1785	88	0.2	1727.6	1520	1595	207.6	132.6				
1710	1785	89	0.2	1727.8	1520	1595	207.8	132.8				
1710	1785	90	0.2	1728	1520	1595	208	133				
1710	1785	91	0.2	1728.2	1520	1595	208.2	133.2				
1710	1785	92	0.2	1728.4	1520	1595	208.4	133.4				
1710	1785	93	0.2	1728.6	1520	1595	208.6	133.6				
1710	1785	94	0.2	1728.8	1520	1595	208.8	133.8				
1710	1785	95	0.2	1729	1520	1595	209	134				
1710	1785	96	0.2	1729.2	1520	1595	209.2	134.2				
1710	1785	97	0.2	1729.4	1520	1595	209.4	134.4				
1710	1785	98	0.2	1729.6	1520	1595	209.6	134.6				
1710	1785	99	0.2	1729.8	1520	1595	209.8	134.8				
1710	1785	100	0.2	1730	1520	1595	210	135				
1710	1785	101	0.2	1730.2	1520	1595	210.2	135.2				
1710	1785	102	0.2	1730.4	1520	1595	210.4	135.4				
1710	1785	103	0.2	1730.6	1520	1595	210.6	135.6				
1710	1785	104	0.2	1730.8	1520	1595	210.8	135.8				
1710	1785	105	0.2	1731	1520	1595	211	136				
1710	1785	106	0.2	1731.2	1520	1595	211.2	136.2				
1710	1785	107	0.2	1731.4	1520	1595	211.4	136.4				
1710	1785	108	0.2	1731.6	1520	1595	211.6	136.6				
1710	1785	109	0.2	1731.8	1520	1595	211.8	136.8				
1710	1785	110	0.2	1732	1520	1595	212	137				

1710	1785	111	0.2	1732.2	1520	1595	212.2	137.2		
1710	1785	112	0.2	1732.4	1520	1595	212.4	137.4		
1710	1785	113	0.2	1732.6	1520	1595	212.6	137.6		
1710	1785	114	0.2	1732.8	1520	1595	212.8	137.8		
1710	1785	115	0.2	1733	1520	1595	213	138		
1710	1785	116	0.2	1733.2	1520	1595	213.2	138.2		
1710	1785	117	0.2	1733.4	1520	1595	213.4	138.4		
1710	1785	118	0.2	1733.6	1520	1595	213.6	138.6		
1710	1785	119	0.2	1733.8	1520	1595	213.8	138.8		
1710	1785	120	0.2	1734	1520	1595	214	139		
1710	1785	121	0.2	1734.2	1520	1595	214.2	139.2		
1710	1785	122	0.2	1734.4	1520	1595	214.4	139.4		
1710	1785	123	0.2	1734.6	1520	1595	214.6	139.6		
1710	1785	124	0.2	1734.8	1520	1595	214.8	139.8		
1710	1785	125	0.2	1735	1520	1595	215	140		
1710	1785	126	0.2	1735.2	1520	1595	215.2	140.2		
1710	1785	127	0.2	1735.4	1520	1595	215.4	140.4		
1710	1785	128	0.2	1735.6	1520	1595	215.6	140.6		
1710	1785	129	0.2	1735.8	1520	1595	215.8	140.8		
1710	1785	130	0.2	1736	1520	1595	216	141		
1710	1785	131	0.2	1736.2	1520	1595	216.2	141.2		
1710	1785	132	0.2	1736.4	1520	1595	216.4	141.4		
1710	1785	133	0.2	1736.6	1520	1595	216.6	141.6		
1710	1785	134	0.2	1736.8	1520	1595	216.8	141.8		
1710	1785	135	0.2	1737	1520	1595	217	142		
1710	1785	136	0.2	1737.2	1520	1595	217.2	142.2		
1710	1785	137	0.2	1737.4	1520	1595	217.4	142.4		
1710	1785	138	0.2	1737.6	1520	1595	217.6	142.6		
1710	1785	139	0.2	1737.8	1520	1595	217.8	142.8		

	1710	1785	140	0.2	1738	1520	1595	218	143				
	1710	1785	141	0.2	1738.2	1520	1595	218.2	143.2				
	1710	1785	142	0.2	1738.4	1520	1595	218.4	143.4				
	1710	1785	143	0.2	1738.6	1520	1595	218.6	143.6				
	1710	1785	144	0.2	1738.8	1520	1595	218.8	143.8				
	1710	1785	145	0.2	1739	1520	1595	219	144				
	1710	1785	146	0.2	1739.2	1520	1595	219.2	144.2				
	1710	1785	147	0.2	1739.4	1520	1595	219.4	144.4				
	1710	1785	148	0.2	1739.6	1520	1595	219.6	144.6				
	1710	1785	149	0.2	1739.8	1520	1595	219.8	144.8				
	1710	1785	150	0.2	1740	1520	1595	220	145				
MTN	1710	1785	151	0.2	1740.2	1520	1595	220.2	145.2	220.2	235	14.8	227.6
	1710	1785	152	0.2	1740.4	1520	1595	220.4	145.4				
	1710	1785	153	0.2	1740.6	1520	1595	220.6	145.6				
	1710	1785	154	0.2	1740.8	1520	1595	220.8	145.8				
	1710	1785	155	0.2	1741	1520	1595	221	146				
	1710	1785	156	0.2	1741.2	1520	1595	221.2	146.2				
	1710	1785	157	0.2	1741.4	1520	1595	221.4	146.4				
	1710	1785	158	0.2	1741.6	1520	1595	221.6	146.6				
	1710	1785	159	0.2	1741.8	1520	1595	221.8	146.8				
	1710	1785	160	0.2	1742	1520	1595	222	147				
	1710	1785	161	0.2	1742.2	1520	1595	222.2	147.2				
	1710	1785	162	0.2	1742.4	1520	1595	222.4	147.4				
	1710	1785	163	0.2	1742.6	1520	1595	222.6	147.6				
	1710	1785	164	0.2	1742.8	1520	1595	222.8	147.8				
	1710	1785	165	0.2	1743	1520	1595	223	148				
	1710	1785	166	0.2	1743.2	1520	1595	223.2	148.2				
	1710	1785	167	0.2	1743.4	1520	1595	223.4	148.4				
	1710	1785	168	0.2	1743.6	1520	1595	223.6	148.6				

1710	1785	169	0.2	1743.8	1520	1595	223.8	148.8		
1710	1785	170	0.2	1744	1520	1595	224	149		
1710	1785	171	0.2	1744.2	1520	1595	224.2	149.2		
1710	1785	172	0.2	1744.4	1520	1595	224.4	149.4		
1710	1785	173	0.2	1744.6	1520	1595	224.6	149.6		
1710	1785	174	0.2	1744.8	1520	1595	224.8	149.8		
1710	1785	175	0.2	1745	1520	1595	225	150		
1710	1785	176	0.2	1745.2	1520	1595	225.2	150.2		
1710	1785	177	0.2	1745.4	1520	1595	225.4	150.4		
1710	1785	178	0.2	1745.6	1520	1595	225.6	150.6		
1710	1785	179	0.2	1745.8	1520	1595	225.8	150.8		
1710	1785	180	0.2	1746	1520	1595	226	151		
1710	1785	181	0.2	1746.2	1520	1595	226.2	151.2		
1710	1785	182	0.2	1746.4	1520	1595	226.4	151.4		
1710	1785	183	0.2	1746.6	1520	1595	226.6	151.6		
1710	1785	184	0.2	1746.8	1520	1595	226.8	151.8		
1710	1785	185	0.2	1747	1520	1595	227	152		
1710	1785	186	0.2	1747.2	1520	1595	227.2	152.2		
1710	1785	187	0.2	1747.4	1520	1595	227.4	152.4		
1710	1785	188	0.2	1747.6	1520	1595	227.6	152.6		
1710	1785	189	0.2	1747.8	1520	1595	227.8	152.8		
1710	1785	190	0.2	1748	1520	1595	228	153		
1710	1785	191	0.2	1748.2	1520	1595	228.2	153.2		
1710	1785	192	0.2	1748.4	1520	1595	228.4	153.4		
1710	1785	193	0.2	1748.6	1520	1595	228.6	153.6		
1710	1785	194	0.2	1748.8	1520	1595	228.8	153.8		
1710	1785	195	0.2	1749	1520	1595	229	154		
1710	1785	196	0.2	1749.2	1520	1595	229.2	154.2		
1710	1785	197	0.2	1749.4	1520	1595	229.4	154.4		

	1710	1785	198	0.2	1749.6	1520	1595	229.6	154.6				
	1710	1785	199	0.2	1749.8	1520	1595	229.8	154.8				
	1710	1785	200	0.2	1750	1520	1595	230	155				
	1710	1785	201	0.2	1750.2	1520	1595	230.2	155.2				
	1710	1785	202	0.2	1750.4	1520	1595	230.4	155.4				
	1710	1785	203	0.2	1750.6	1520	1595	230.6	155.6				
	1710	1785	204	0.2	1750.8	1520	1595	230.8	155.8				
	1710	1785	205	0.2	1751	1520	1595	231	156				
	1710	1785	206	0.2	1751.2	1520	1595	231.2	156.2				
	1710	1785	207	0.2	1751.4	1520	1595	231.4	156.4				
	1710	1785	208	0.2	1751.6	1520	1595	231.6	156.6				
	1710	1785	209	0.2	1751.8	1520	1595	231.8	156.8				
	1710	1785	210	0.2	1752	1520	1595	232	157				
	1710	1785	211	0.2	1752.2	1520	1595	232.2	157.2				
	1710	1785	212	0.2	1752.4	1520	1595	232.4	157.4				
	1710	1785	213	0.2	1752.6	1520	1595	232.6	157.6				
	1710	1785	214	0.2	1752.8	1520	1595	232.8	157.8				
	1710	1785	215	0.2	1753	1520	1595	233	158				
	1710	1785	216	0.2	1753.2	1520	1595	233.2	158.2				
	1710	1785	217	0.2	1753.4	1520	1595	233.4	158.4				
	1710	1785	218	0.2	1753.6	1520	1595	233.6	158.6				
	1710	1785	219	0.2	1753.8	1520	1595	233.8	158.8				
	1710	1785	220	0.2	1754	1520	1595	234	159				
	1710	1785	221	0.2	1754.2	1520	1595	234.2	159.2				
	1710	1785	222	0.2	1754.4	1520	1595	234.4	159.4				
	1710	1785	223	0.2	1754.6	1520	1595	234.6	159.6				
	1710	1785	224	0.2	1754.8	1520	1595	234.8	159.8				
	1710	1785	225	0.2	1755	1520	1595	235	160				
AIRTEL	1710	1785	226	0.2	1755.2	1520	1595	235.2	160.2	235.2	250	14.8	242.6

1710	1785	227	0.2	1755.4	1520	1595	235.4	160.4		
1710	1785	228	0.2	1755.6	1520	1595	235.6	160.6		
1710	1785	229	0.2	1755.8	1520	1595	235.8	160.8		
1710	1785	230	0.2	1756	1520	1595	236	161		
1710	1785	231	0.2	1756.2	1520	1595	236.2	161.2		
1710	1785	232	0.2	1756.4	1520	1595	236.4	161.4		
1710	1785	233	0.2	1756.6	1520	1595	236.6	161.6		
1710	1785	234	0.2	1756.8	1520	1595	236.8	161.8		
1710	1785	235	0.2	1757	1520	1595	237	162		
1710	1785	236	0.2	1757.2	1520	1595	237.2	162.2		
1710	1785	237	0.2	1757.4	1520	1595	237.4	162.4		
1710	1785	238	0.2	1757.6	1520	1595	237.6	162.6		
1710	1785	239	0.2	1757.8	1520	1595	237.8	162.8		
1710	1785	240	0.2	1758	1520	1595	238	163		
1710	1785	241	0.2	1758.2	1520	1595	238.2	163.2		
1710	1785	242	0.2	1758.4	1520	1595	238.4	163.4		
1710	1785	243	0.2	1758.6	1520	1595	238.6	163.6		
1710	1785	244	0.2	1758.8	1520	1595	238.8	163.8		
1710	1785	245	0.2	1759	1520	1595	239	164		
1710	1785	246	0.2	1759.2	1520	1595	239.2	164.2		
1710	1785	247	0.2	1759.4	1520	1595	239.4	164.4		
1710	1785	248	0.2	1759.6	1520	1595	239.6	164.6		
1710	1785	249	0.2	1759.8	1520	1595	239.8	164.8		
1710	1785	250	0.2	1760	1520	1595	240	165		
1710	1785	251	0.2	1760.2	1520	1595	240.2	165.2		
1710	1785	252	0.2	1760.4	1520	1595	240.4	165.4		
1710	1785	253	0.2	1760.6	1520	1595	240.6	165.6		
1710	1785	254	0.2	1760.8	1520	1595	240.8	165.8		
1710	1785	255	0.2	1761	1520	1595	241	166		

1710	1785	256	0.2	1761.2	1520	1595	241.2	166.2		
1710	1785	257	0.2	1761.4	1520	1595	241.4	166.4		
1710	1785	258	0.2	1761.6	1520	1595	241.6	166.6		
1710	1785	259	0.2	1761.8	1520	1595	241.8	166.8		
1710	1785	260	0.2	1762	1520	1595	242	167		
1710	1785	261	0.2	1762.2	1520	1595	242.2	167.2		
1710	1785	262	0.2	1762.4	1520	1595	242.4	167.4		
1710	1785	263	0.2	1762.6	1520	1595	242.6	167.6		
1710	1785	264	0.2	1762.8	1520	1595	242.8	167.8		
1710	1785	265	0.2	1763	1520	1595	243	168		
1710	1785	266	0.2	1763.2	1520	1595	243.2	168.2		
1710	1785	267	0.2	1763.4	1520	1595	243.4	168.4		
1710	1785	268	0.2	1763.6	1520	1595	243.6	168.6		
1710	1785	269	0.2	1763.8	1520	1595	243.8	168.8		
1710	1785	270	0.2	1764	1520	1595	244	169		
1710	1785	271	0.2	1764.2	1520	1595	244.2	169.2		
1710	1785	272	0.2	1764.4	1520	1595	244.4	169.4		
1710	1785	273	0.2	1764.6	1520	1595	244.6	169.6		
1710	1785	274	0.2	1764.8	1520	1595	244.8	169.8		
1710	1785	275	0.2	1765	1520	1595	245	170		
1710	1785	276	0.2	1765.2	1520	1595	245.2	170.2		
1710	1785	277	0.2	1765.4	1520	1595	245.4	170.4		
1710	1785	278	0.2	1765.6	1520	1595	245.6	170.6		
1710	1785	279	0.2	1765.8	1520	1595	245.8	170.8		
1710	1785	280	0.2	1766	1520	1595	246	171		
1710	1785	281	0.2	1766.2	1520	1595	246.2	171.2		
1710	1785	282	0.2	1766.4	1520	1595	246.4	171.4		
1710	1785	283	0.2	1766.6	1520	1595	246.6	171.6		
1710	1785	284	0.2	1766.8	1520	1595	246.8	171.8		

	1710	1785	285	0.2	1767	1520	1595	247	172				
	1710	1785	286	0.2	1767.2	1520	1595	247.2	172.2				
	1710	1785	287	0.2	1767.4	1520	1595	247.4	172.4				
	1710	1785	288	0.2	1767.6	1520	1595	247.6	172.6				
	1710	1785	289	0.2	1767.8	1520	1595	247.8	172.8				
	1710	1785	290	0.2	1768	1520	1595	248	173				
	1710	1785	291	0.2	1768.2	1520	1595	248.2	173.2				
	1710	1785	292	0.2	1768.4	1520	1595	248.4	173.4				
	1710	1785	293	0.2	1768.6	1520	1595	248.6	173.6				
	1710	1785	294	0.2	1768.8	1520	1595	248.8	173.8				
	1710	1785	295	0.2	1769	1520	1595	249	174				
	1710	1785	296	0.2	1769.2	1520	1595	249.2	174.2				
	1710	1785	297	0.2	1769.4	1520	1595	249.4	174.4				
	1710	1785	298	0.2	1769.6	1520	1595	249.6	174.6				
	1710	1785	299	0.2	1769.8	1520	1595	249.8	174.8				
	1710	1785	300	0.2	1770	1520	1595	250	175				
9Mobile	1710	1785	301	0.2	1770.2	1520	1595	250.2	175.2	250.2	265	14.8	257.6
	1710	1785	302	0.2	1770.4	1520	1595	250.4	175.4				
	1710	1785	303	0.2	1770.6	1520	1595	250.6	175.6				
	1710	1785	304	0.2	1770.8	1520	1595	250.8	175.8				
	1710	1785	305	0.2	1771	1520	1595	251	176				
	1710	1785	306	0.2	1771.2	1520	1595	251.2	176.2				
	1710	1785	307	0.2	1771.4	1520	1595	251.4	176.4				
	1710	1785	308	0.2	1771.6	1520	1595	251.6	176.6				
	1710	1785	309	0.2	1771.8	1520	1595	251.8	176.8				
	1710	1785	310	0.2	1772	1520	1595	252	177				
	1710	1785	311	0.2	1772.2	1520	1595	252.2	177.2				
	1710	1785	312	0.2	1772.4	1520	1595	252.4	177.4				
	1710	1785	313	0.2	1772.6	1520	1595	252.6	177.6				

1710	1785	314	0.2	1772.8	1520	1595	252.8	177.8		
1710	1785	315	0.2	1773	1520	1595	253	178		
1710	1785	316	0.2	1773.2	1520	1595	253.2	178.2		
1710	1785	317	0.2	1773.4	1520	1595	253.4	178.4		
1710	1785	318	0.2	1773.6	1520	1595	253.6	178.6		
1710	1785	319	0.2	1773.8	1520	1595	253.8	178.8		
1710	1785	320	0.2	1774	1520	1595	254	179		
1710	1785	321	0.2	1774.2	1520	1595	254.2	179.2		
1710	1785	322	0.2	1774.4	1520	1595	254.4	179.4		
1710	1785	323	0.2	1774.6	1520	1595	254.6	179.6		
1710	1785	324	0.2	1774.8	1520	1595	254.8	179.8		
1710	1785	325	0.2	1775	1520	1595	255	180		
1710	1785	326	0.2	1775.2	1520	1595	255.2	180.2		
1710	1785	327	0.2	1775.4	1520	1595	255.4	180.4		
1710	1785	328	0.2	1775.6	1520	1595	255.6	180.6		
1710	1785	329	0.2	1775.8	1520	1595	255.8	180.8		
1710	1785	330	0.2	1776	1520	1595	256	181		
1710	1785	331	0.2	1776.2	1520	1595	256.2	181.2		
1710	1785	332	0.2	1776.4	1520	1595	256.4	181.4		
1710	1785	333	0.2	1776.6	1520	1595	256.6	181.6		
1710	1785	334	0.2	1776.8	1520	1595	256.8	181.8		
1710	1785	335	0.2	1777	1520	1595	257	182		
1710	1785	336	0.2	1777.2	1520	1595	257.2	182.2		
1710	1785	337	0.2	1777.4	1520	1595	257.4	182.4		
1710	1785	338	0.2	1777.6	1520	1595	257.6	182.6		
1710	1785	339	0.2	1777.8	1520	1595	257.8	182.8		
1710	1785	340	0.2	1778	1520	1595	258	183		
1710	1785	341	0.2	1778.2	1520	1595	258.2	183.2		
1710	1785	342	0.2	1778.4	1520	1595	258.4	183.4		

1710	1785	343	0.2	1778.6	1520	1595	258.6	183.6				
1710	1785	344	0.2	1778.8	1520	1595	258.8	183.8				
1710	1785	345	0.2	1779	1520	1595	259	184				
1710	1785	346	0.2	1779.2	1520	1595	259.2	184.2				
1710	1785	347	0.2	1779.4	1520	1595	259.4	184.4				
1710	1785	348	0.2	1779.6	1520	1595	259.6	184.6				
1710	1785	349	0.2	1779.8	1520	1595	259.8	184.8				
1710	1785	350	0.2	1780	1520	1595	260	185				
1710	1785	351	0.2	1780.2	1520	1595	260.2	185.2				
1710	1785	352	0.2	1780.4	1520	1595	260.4	185.4				
1710	1785	353	0.2	1780.6	1520	1595	260.6	185.6				
1710	1785	354	0.2	1780.8	1520	1595	260.8	185.8				
1710	1785	355	0.2	1781	1520	1595	261	186				
1710	1785	356	0.2	1781.2	1520	1595	261.2	186.2				
1710	1785	357	0.2	1781.4	1520	1595	261.4	186.4				
1710	1785	358	0.2	1781.6	1520	1595	261.6	186.6				
1710	1785	359	0.2	1781.8	1520	1595	261.8	186.8				
1710	1785	360	0.2	1782	1520	1595	262	187				
1710	1785	361	0.2	1782.2	1520	1595	262.2	187.2				
1710	1785	362	0.2	1782.4	1520	1595	262.4	187.4				
1710	1785	363	0.2	1782.6	1520	1595	262.6	187.6				
1710	1785	364	0.2	1782.8	1520	1595	262.8	187.8				
1710	1785	365	0.2	1783	1520	1595	263	188				
1710	1785	366	0.2	1783.2	1520	1595	263.2	188.2				
1710	1785	367	0.2	1783.4	1520	1595	263.4	188.4				
1710	1785	368	0.2	1783.6	1520	1595	263.6	188.6				
1710	1785	369	0.2	1783.8	1520	1595	263.8	188.8				
1710	1785	370	0.2	1784	1520	1595	264	189				
1710	1785	371	0.2	1784.2	1520	1595	264.2	189.2				

	1710	1785	372	0.2	1784.4	1520	1595	264.4	189.4				
	1710	1785	373	0.2	1784.6	1520	1595	264.6	189.6				
	1710	1785	374	0.2	1784.8	1520	1595	264.8	189.8				
	1710	1785	375	0.2	1785	1520	1595	265	190				

Appendix C

Intermediate Frequency and Mixer selection analysis for Downlink spectrum

Downlink Frequencies 1710 – 1785MHz													
Operator	BPF (1825.5) Downlink		Channel Number	Channel bandwidth (0.2MHz)	Channels	Mixer Input		Mixer Output		IF Filter Band (MHz)VCO fixed at 1520			
	Min	Max				Min	Max	Min (1520)	Max (1595)	Min	Max	IF B/W	IF Center freq
NTEL	1805	1880	1	0.2	1805.2	1520	1595	285.2	210.2	285.2	300	14.8	292.6
	1805	1880	2	0.2	1805.4	1520	1595	285.4	210.4				
	1805	1880	3	0.2	1805.6	1520	1595	285.6	210.6				
	1805	1880	4	0.2	1805.8	1520	1595	285.8	210.8				
	1805	1880	5	0.2	1806	1520	1595	286	211				
	1805	1880	6	0.2	1806.2	1520	1595	286.2	211.2				
	1805	1880	7	0.2	1806.4	1520	1595	286.4	211.4				
	1805	1880	8	0.2	1806.6	1520	1595	286.6	211.6				
	1805	1880	9	0.2	1806.8	1520	1595	286.8	211.8				
	1805	1880	10	0.2	1807	1520	1595	287	212				
	1805	1880	11	0.2	1807.2	1520	1595	287.2	212.2				
	1805	1880	12	0.2	1807.4	1520	1595	287.4	212.4				
	1805	1880	13	0.2	1807.6	1520	1595	287.6	212.6				
	1805	1880	14	0.2	1807.8	1520	1595	287.8	212.8				
	1805	1880	15	0.2	1808	1520	1595	288	213				
	1805	1880	16	0.2	1808.2	1520	1595	288.2	213.2				
	1805	1880	17	0.2	1808.4	1520	1595	288.4	213.4				
	1805	1880	18	0.2	1808.6	1520	1595	288.6	213.6				
	1805	1880	19	0.2	1808.8	1520	1595	288.8	213.8				
	1805	1880	20	0.2	1809	1520	1595	289	214				
	1805	1880	21	0.2	1809.2	1520	1595	289.2	214.2				
	1805	1880	22	0.2	1809.4	1520	1595	289.4	214.4				
	1805	1880	23	0.2	1809.6	1520	1595	289.6	214.6				

1805	1880	24	0.2	1809.8	1520	1595	289.8	214.8		
1805	1880	25	0.2	1810	1520	1595	290	215		
1805	1880	26	0.2	1810.2	1520	1595	290.2	215.2		
1805	1880	27	0.2	1810.4	1520	1595	290.4	215.4		
1805	1880	28	0.2	1810.6	1520	1595	290.6	215.6		
1805	1880	29	0.2	1810.8	1520	1595	290.8	215.8		
1805	1880	30	0.2	1811	1520	1595	291	216		
1805	1880	31	0.2	1811.2	1520	1595	291.2	216.2		
1805	1880	32	0.2	1811.4	1520	1595	291.4	216.4		
1805	1880	33	0.2	1811.6	1520	1595	291.6	216.6		
1805	1880	34	0.2	1811.8	1520	1595	291.8	216.8		
1805	1880	35	0.2	1812	1520	1595	292	217		
1805	1880	36	0.2	1812.2	1520	1595	292.2	217.2		
1805	1880	37	0.2	1812.4	1520	1595	292.4	217.4		
1805	1880	38	0.2	1812.6	1520	1595	292.6	217.6		
1805	1880	39	0.2	1812.8	1520	1595	292.8	217.8		
1805	1880	40	0.2	1813	1520	1595	293	218		
1805	1880	41	0.2	1813.2	1520	1595	293.2	218.2		
1805	1880	42	0.2	1813.4	1520	1595	293.4	218.4		
1805	1880	43	0.2	1813.6	1520	1595	293.6	218.6		
1805	1880	44	0.2	1813.8	1520	1595	293.8	218.8		
1805	1880	45	0.2	1814	1520	1595	294	219		
1805	1880	46	0.2	1814.2	1520	1595	294.2	219.2		
1805	1880	47	0.2	1814.4	1520	1595	294.4	219.4		
1805	1880	48	0.2	1814.6	1520	1595	294.6	219.6		
1805	1880	49	0.2	1814.8	1520	1595	294.8	219.8		
1805	1880	50	0.2	1815	1520	1595	295	220		
1805	1880	51	0.2	1815.2	1520	1595	295.2	220.2		
1805	1880	52	0.2	1815.4	1520	1595	295.4	220.4		

	1805	1880	53	0.2	1815.6	1520	1595	295.6	220.6				
	1805	1880	54	0.2	1815.8	1520	1595	295.8	220.8				
	1805	1880	55	0.2	1816	1520	1595	296	221				
	1805	1880	56	0.2	1816.2	1520	1595	296.2	221.2				
	1805	1880	57	0.2	1816.4	1520	1595	296.4	221.4				
	1805	1880	58	0.2	1816.6	1520	1595	296.6	221.6				
	1805	1880	59	0.2	1816.8	1520	1595	296.8	221.8				
	1805	1880	60	0.2	1817	1520	1595	297	222				
	1805	1880	61	0.2	1817.2	1520	1595	297.2	222.2				
	1805	1880	62	0.2	1817.4	1520	1595	297.4	222.4				
	1805	1880	63	0.2	1817.6	1520	1595	297.6	222.6				
	1805	1880	64	0.2	1817.8	1520	1595	297.8	222.8				
	1805	1880	65	0.2	1818	1520	1595	298	223				
	1805	1880	66	0.2	1818.2	1520	1595	298.2	223.2				
	1805	1880	67	0.2	1818.4	1520	1595	298.4	223.4				
	1805	1880	68	0.2	1818.6	1520	1595	298.6	223.6				
	1805	1880	69	0.2	1818.8	1520	1595	298.8	223.8				
	1805	1880	70	0.2	1819	1520	1595	299	224				
	1805	1880	71	0.2	1819.2	1520	1595	299.2	224.2				
	1805	1880	72	0.2	1819.4	1520	1595	299.4	224.4				
	1805	1880	73	0.2	1819.6	1520	1595	299.6	224.6				
	1805	1880	74	0.2	1819.8	1520	1595	299.8	224.8				
	1805	1880	75	0.2	1820	1520	1595	300	225				
Globacom	1805	1880	76	0.2	1820.2	1520	1595	300.2	225.2	300.2	315	14.8	307.6
	1805	1880	77	0.2	1820.4	1520	1595	300.4	225.4				
	1805	1880	78	0.2	1820.6	1520	1595	300.6	225.6				
	1805	1880	79	0.2	1820.8	1520	1595	300.8	225.8				
	1805	1880	80	0.2	1821	1520	1595	301	226				
	1805	1880	81	0.2	1821.2	1520	1595	301.2	226.2				

1805	1880	82	0.2	1821.4	1520	1595	301.4	226.4				
1805	1880	83	0.2	1821.6	1520	1595	301.6	226.6				
1805	1880	84	0.2	1821.8	1520	1595	301.8	226.8				
1805	1880	85	0.2	1822	1520	1595	302	227				
1805	1880	86	0.2	1822.2	1520	1595	302.2	227.2				
1805	1880	87	0.2	1822.4	1520	1595	302.4	227.4				
1805	1880	88	0.2	1822.6	1520	1595	302.6	227.6				
1805	1880	89	0.2	1822.8	1520	1595	302.8	227.8				
1805	1880	90	0.2	1823	1520	1595	303	228				
1805	1880	91	0.2	1823.2	1520	1595	303.2	228.2				
1805	1880	92	0.2	1823.4	1520	1595	303.4	228.4				
1805	1880	93	0.2	1823.6	1520	1595	303.6	228.6				
1805	1880	94	0.2	1823.8	1520	1595	303.8	228.8				
1805	1880	95	0.2	1824	1520	1595	304	229				
1805	1880	96	0.2	1824.2	1520	1595	304.2	229.2				
1805	1880	97	0.2	1824.4	1520	1595	304.4	229.4				
1805	1880	98	0.2	1824.6	1520	1595	304.6	229.6				
1805	1880	99	0.2	1824.8	1520	1595	304.8	229.8				
1805	1880	100	0.2	1825	1520	1595	305	230				
1805	1880	101	0.2	1825.2	1520	1595	305.2	230.2				
1805	1880	102	0.2	1825.4	1520	1595	305.4	230.4				
1805	1880	103	0.2	1825.6	1520	1595	305.6	230.6				
1805	1880	104	0.2	1825.8	1520	1595	305.8	230.8				
1805	1880	105	0.2	1826	1520	1595	306	231				
1805	1880	106	0.2	1826.2	1520	1595	306.2	231.2				
1805	1880	107	0.2	1826.4	1520	1595	306.4	231.4				
1805	1880	108	0.2	1826.6	1520	1595	306.6	231.6				
1805	1880	109	0.2	1826.8	1520	1595	306.8	231.8				
1805	1880	110	0.2	1827	1520	1595	307	232				

1805	1880	111	0.2	1827.2	1520	1595	307.2	232.2		
1805	1880	112	0.2	1827.4	1520	1595	307.4	232.4		
1805	1880	113	0.2	1827.6	1520	1595	307.6	232.6		
1805	1880	114	0.2	1827.8	1520	1595	307.8	232.8		
1805	1880	115	0.2	1828	1520	1595	308	233		
1805	1880	116	0.2	1828.2	1520	1595	308.2	233.2		
1805	1880	117	0.2	1828.4	1520	1595	308.4	233.4		
1805	1880	118	0.2	1828.6	1520	1595	308.6	233.6		
1805	1880	119	0.2	1828.8	1520	1595	308.8	233.8		
1805	1880	120	0.2	1829	1520	1595	309	234		
1805	1880	121	0.2	1829.2	1520	1595	309.2	234.2		
1805	1880	122	0.2	1829.4	1520	1595	309.4	234.4		
1805	1880	123	0.2	1829.6	1520	1595	309.6	234.6		
1805	1880	124	0.2	1829.8	1520	1595	309.8	234.8		
1805	1880	125	0.2	1830	1520	1595	310	235		
1805	1880	126	0.2	1830.2	1520	1595	310.2	235.2		
1805	1880	127	0.2	1830.4	1520	1595	310.4	235.4		
1805	1880	128	0.2	1830.6	1520	1595	310.6	235.6		
1805	1880	129	0.2	1830.8	1520	1595	310.8	235.8		
1805	1880	130	0.2	1831	1520	1595	311	236		
1805	1880	131	0.2	1831.2	1520	1595	311.2	236.2		
1805	1880	132	0.2	1831.4	1520	1595	311.4	236.4		
1805	1880	133	0.2	1831.6	1520	1595	311.6	236.6		
1805	1880	134	0.2	1831.8	1520	1595	311.8	236.8		
1805	1880	135	0.2	1832	1520	1595	312	237		
1805	1880	136	0.2	1832.2	1520	1595	312.2	237.2		
1805	1880	137	0.2	1832.4	1520	1595	312.4	237.4		
1805	1880	138	0.2	1832.6	1520	1595	312.6	237.6		
1805	1880	139	0.2	1832.8	1520	1595	312.8	237.8		

	1805	1880	140	0.2	1833	1520	1595	313	238				
	1805	1880	141	0.2	1833.2	1520	1595	313.2	238.2				
	1805	1880	142	0.2	1833.4	1520	1595	313.4	238.4				
	1805	1880	143	0.2	1833.6	1520	1595	313.6	238.6				
	1805	1880	144	0.2	1833.8	1520	1595	313.8	238.8				
	1805	1880	145	0.2	1834	1520	1595	314	239				
	1805	1880	146	0.2	1834.2	1520	1595	314.2	239.2				
	1805	1880	147	0.2	1834.4	1520	1595	314.4	239.4				
	1805	1880	148	0.2	1834.6	1520	1595	314.6	239.6				
	1805	1880	149	0.2	1834.8	1520	1595	314.8	239.8				
	1805	1880	150	0.2	1835	1520	1595	315	240				
MTN	1805	1880	151	0.2	1835.2	1520	1595	315.2	240.2	315.2	330	14.8	322.6
	1805	1880	152	0.2	1835.4	1520	1595	315.4	240.4				
	1805	1880	153	0.2	1835.6	1520	1595	315.6	240.6				
	1805	1880	154	0.2	1835.8	1520	1595	315.8	240.8				
	1805	1880	155	0.2	1836	1520	1595	316	241				
	1805	1880	156	0.2	1836.2	1520	1595	316.2	241.2				
	1805	1880	157	0.2	1836.4	1520	1595	316.4	241.4				
	1805	1880	158	0.2	1836.6	1520	1595	316.6	241.6				
	1805	1880	159	0.2	1836.8	1520	1595	316.8	241.8				
	1805	1880	160	0.2	1837	1520	1595	317	242				
	1805	1880	161	0.2	1837.2	1520	1595	317.2	242.2				
	1805	1880	162	0.2	1837.4	1520	1595	317.4	242.4				
	1805	1880	163	0.2	1837.6	1520	1595	317.6	242.6				
	1805	1880	164	0.2	1837.8	1520	1595	317.8	242.8				
	1805	1880	165	0.2	1838	1520	1595	318	243				
	1805	1880	166	0.2	1838.2	1520	1595	318.2	243.2				
	1805	1880	167	0.2	1838.4	1520	1595	318.4	243.4				
	1805	1880	168	0.2	1838.6	1520	1595	318.6	243.6				

1805	1880	169	0.2	1838.8	1520	1595	318.8	243.8		
1805	1880	170	0.2	1839	1520	1595	319	244		
1805	1880	171	0.2	1839.2	1520	1595	319.2	244.2		
1805	1880	172	0.2	1839.4	1520	1595	319.4	244.4		
1805	1880	173	0.2	1839.6	1520	1595	319.6	244.6		
1805	1880	174	0.2	1839.8	1520	1595	319.8	244.8		
1805	1880	175	0.2	1840	1520	1595	320	245		
1805	1880	176	0.2	1840.2	1520	1595	320.2	245.2		
1805	1880	177	0.2	1840.4	1520	1595	320.4	245.4		
1805	1880	178	0.2	1840.6	1520	1595	320.6	245.6		
1805	1880	179	0.2	1840.8	1520	1595	320.8	245.8		
1805	1880	180	0.2	1841	1520	1595	321	246		
1805	1880	181	0.2	1841.2	1520	1595	321.2	246.2		
1805	1880	182	0.2	1841.4	1520	1595	321.4	246.4		
1805	1880	183	0.2	1841.6	1520	1595	321.6	246.6		
1805	1880	184	0.2	1841.8	1520	1595	321.8	246.8		
1805	1880	185	0.2	1842	1520	1595	322	247		
1805	1880	186	0.2	1842.2	1520	1595	322.2	247.2		
1805	1880	187	0.2	1842.4	1520	1595	322.4	247.4		
1805	1880	188	0.2	1842.6	1520	1595	322.6	247.6		
1805	1880	189	0.2	1842.8	1520	1595	322.8	247.8		
1805	1880	190	0.2	1843	1520	1595	323	248		
1805	1880	191	0.2	1843.2	1520	1595	323.2	248.2		
1805	1880	192	0.2	1843.4	1520	1595	323.4	248.4		
1805	1880	193	0.2	1843.6	1520	1595	323.6	248.6		
1805	1880	194	0.2	1843.8	1520	1595	323.8	248.8		
1805	1880	195	0.2	1844	1520	1595	324	249		
1805	1880	196	0.2	1844.2	1520	1595	324.2	249.2		
1805	1880	197	0.2	1844.4	1520	1595	324.4	249.4		

	1805	1880	198	0.2	1844.6	1520	1595	324.6	249.6				
	1805	1880	199	0.2	1844.8	1520	1595	324.8	249.8				
	1805	1880	200	0.2	1845	1520	1595	325	250				
	1805	1880	201	0.2	1845.2	1520	1595	325.2	250.2				
	1805	1880	202	0.2	1845.4	1520	1595	325.4	250.4				
	1805	1880	203	0.2	1845.6	1520	1595	325.6	250.6				
	1805	1880	204	0.2	1845.8	1520	1595	325.8	250.8				
	1805	1880	205	0.2	1846	1520	1595	326	251				
	1805	1880	206	0.2	1846.2	1520	1595	326.2	251.2				
	1805	1880	207	0.2	1846.4	1520	1595	326.4	251.4				
	1805	1880	208	0.2	1846.6	1520	1595	326.6	251.6				
	1805	1880	209	0.2	1846.8	1520	1595	326.8	251.8				
	1805	1880	210	0.2	1847	1520	1595	327	252				
	1805	1880	211	0.2	1847.2	1520	1595	327.2	252.2				
	1805	1880	212	0.2	1847.4	1520	1595	327.4	252.4				
	1805	1880	213	0.2	1847.6	1520	1595	327.6	252.6				
	1805	1880	214	0.2	1847.8	1520	1595	327.8	252.8				
	1805	1880	215	0.2	1848	1520	1595	328	253				
	1805	1880	216	0.2	1848.2	1520	1595	328.2	253.2				
	1805	1880	217	0.2	1848.4	1520	1595	328.4	253.4				
	1805	1880	218	0.2	1848.6	1520	1595	328.6	253.6				
	1805	1880	219	0.2	1848.8	1520	1595	328.8	253.8				
	1805	1880	220	0.2	1849	1520	1595	329	254				
	1805	1880	221	0.2	1849.2	1520	1595	329.2	254.2				
	1805	1880	222	0.2	1849.4	1520	1595	329.4	254.4				
	1805	1880	223	0.2	1849.6	1520	1595	329.6	254.6				
	1805	1880	224	0.2	1849.8	1520	1595	329.8	254.8				
	1805	1880	225	0.2	1850	1520	1595	330	255				
AIRTEL	1805	1880	226	0.2	1850.2	1520	1595	330.2	255.2	330.2	345	14.8	337.6

1805	1880	227	0.2	1850.4	1520	1595	330.4	255.4				
1805	1880	228	0.2	1850.6	1520	1595	330.6	255.6				
1805	1880	229	0.2	1850.8	1520	1595	330.8	255.8				
1805	1880	230	0.2	1851	1520	1595	331	256				
1805	1880	231	0.2	1851.2	1520	1595	331.2	256.2				
1805	1880	232	0.2	1851.4	1520	1595	331.4	256.4				
1805	1880	233	0.2	1851.6	1520	1595	331.6	256.6				
1805	1880	234	0.2	1851.8	1520	1595	331.8	256.8				
1805	1880	235	0.2	1852	1520	1595	332	257				
1805	1880	236	0.2	1852.2	1520	1595	332.2	257.2				
1805	1880	237	0.2	1852.4	1520	1595	332.4	257.4				
1805	1880	238	0.2	1852.6	1520	1595	332.6	257.6				
1805	1880	239	0.2	1852.8	1520	1595	332.8	257.8				
1805	1880	240	0.2	1853	1520	1595	333	258				
1805	1880	241	0.2	1853.2	1520	1595	333.2	258.2				
1805	1880	242	0.2	1853.4	1520	1595	333.4	258.4				
1805	1880	243	0.2	1853.6	1520	1595	333.6	258.6				
1805	1880	244	0.2	1853.8	1520	1595	333.8	258.8				
1805	1880	245	0.2	1854	1520	1595	334	259				
1805	1880	246	0.2	1854.2	1520	1595	334.2	259.2				
1805	1880	247	0.2	1854.4	1520	1595	334.4	259.4				
1805	1880	248	0.2	1854.6	1520	1595	334.6	259.6				
1805	1880	249	0.2	1854.8	1520	1595	334.8	259.8				
1805	1880	250	0.2	1855	1520	1595	335	260				
1805	1880	251	0.2	1855.2	1520	1595	335.2	260.2				
1805	1880	252	0.2	1855.4	1520	1595	335.4	260.4				
1805	1880	253	0.2	1855.6	1520	1595	335.6	260.6				
1805	1880	254	0.2	1855.8	1520	1595	335.8	260.8				
1805	1880	255	0.2	1856	1520	1595	336	261				

1805	1880	256	0.2	1856.2	1520	1595	336.2	261.2		
1805	1880	257	0.2	1856.4	1520	1595	336.4	261.4		
1805	1880	258	0.2	1856.6	1520	1595	336.6	261.6		
1805	1880	259	0.2	1856.8	1520	1595	336.8	261.8		
1805	1880	260	0.2	1857	1520	1595	337	262		
1805	1880	261	0.2	1857.2	1520	1595	337.2	262.2		
1805	1880	262	0.2	1857.4	1520	1595	337.4	262.4		
1805	1880	263	0.2	1857.6	1520	1595	337.6	262.6		
1805	1880	264	0.2	1857.8	1520	1595	337.8	262.8		
1805	1880	265	0.2	1858	1520	1595	338	263		
1805	1880	266	0.2	1858.2	1520	1595	338.2	263.2		
1805	1880	267	0.2	1858.4	1520	1595	338.4	263.4		
1805	1880	268	0.2	1858.6	1520	1595	338.6	263.6		
1805	1880	269	0.2	1858.8	1520	1595	338.8	263.8		
1805	1880	270	0.2	1859	1520	1595	339	264		
1805	1880	271	0.2	1859.2	1520	1595	339.2	264.2		
1805	1880	272	0.2	1859.4	1520	1595	339.4	264.4		
1805	1880	273	0.2	1859.6	1520	1595	339.6	264.6		
1805	1880	274	0.2	1859.8	1520	1595	339.8	264.8		
1805	1880	275	0.2	1860	1520	1595	340	265		
1805	1880	276	0.2	1860.2	1520	1595	340.2	265.2		
1805	1880	277	0.2	1860.4	1520	1595	340.4	265.4		
1805	1880	278	0.2	1860.6	1520	1595	340.6	265.6		
1805	1880	279	0.2	1860.8	1520	1595	340.8	265.8		
1805	1880	280	0.2	1861	1520	1595	341	266		
1805	1880	281	0.2	1861.2	1520	1595	341.2	266.2		
1805	1880	282	0.2	1861.4	1520	1595	341.4	266.4		
1805	1880	283	0.2	1861.6	1520	1595	341.6	266.6		
1805	1880	284	0.2	1861.8	1520	1595	341.8	266.8		

	1805	1880	285	0.2	1862	1520	1595	342	267				
	1805	1880	286	0.2	1862.2	1520	1595	342.2	267.2				
	1805	1880	287	0.2	1862.4	1520	1595	342.4	267.4				
	1805	1880	288	0.2	1862.6	1520	1595	342.6	267.6				
	1805	1880	289	0.2	1862.8	1520	1595	342.8	267.8				
	1805	1880	290	0.2	1863	1520	1595	343	268				
	1805	1880	291	0.2	1863.2	1520	1595	343.2	268.2				
	1805	1880	292	0.2	1863.4	1520	1595	343.4	268.4				
	1805	1880	293	0.2	1863.6	1520	1595	343.6	268.6				
	1805	1880	294	0.2	1863.8	1520	1595	343.8	268.8				
	1805	1880	295	0.2	1864	1520	1595	344	269				
	1805	1880	296	0.2	1864.2	1520	1595	344.2	269.2				
	1805	1880	297	0.2	1864.4	1520	1595	344.4	269.4				
	1805	1880	298	0.2	1864.6	1520	1595	344.6	269.6				
	1805	1880	299	0.2	1864.8	1520	1595	344.8	269.8				
	1805	1880	300	0.2	1865	1520	1595	345	270				
9Mobile	1805	1880	301	0.2	1865.2	1520	1595	345.2	270.2	345.2	360	14.8	352.6
	1805	1880	302	0.2	1865.4	1520	1595	345.4	270.4				
	1805	1880	303	0.2	1865.6	1520	1595	345.6	270.6				
	1805	1880	304	0.2	1865.8	1520	1595	345.8	270.8				
	1805	1880	305	0.2	1866	1520	1595	346	271				
	1805	1880	306	0.2	1866.2	1520	1595	346.2	271.2				
	1805	1880	307	0.2	1866.4	1520	1595	346.4	271.4				
	1805	1880	308	0.2	1866.6	1520	1595	346.6	271.6				
	1805	1880	309	0.2	1866.8	1520	1595	346.8	271.8				
	1805	1880	310	0.2	1867	1520	1595	347	272				
	1805	1880	311	0.2	1867.2	1520	1595	347.2	272.2				
	1805	1880	312	0.2	1867.4	1520	1595	347.4	272.4				
	1805	1880	313	0.2	1867.6	1520	1595	347.6	272.6				

1805	1880	314	0.2	1867.8	1520	1595	347.8	272.8		
1805	1880	315	0.2	1868	1520	1595	348	273		
1805	1880	316	0.2	1868.2	1520	1595	348.2	273.2		
1805	1880	317	0.2	1868.4	1520	1595	348.4	273.4		
1805	1880	318	0.2	1868.6	1520	1595	348.6	273.6		
1805	1880	319	0.2	1868.8	1520	1595	348.8	273.8		
1805	1880	320	0.2	1869	1520	1595	349	274		
1805	1880	321	0.2	1869.2	1520	1595	349.2	274.2		
1805	1880	322	0.2	1869.4	1520	1595	349.4	274.4		
1805	1880	323	0.2	1869.6	1520	1595	349.6	274.6		
1805	1880	324	0.2	1869.8	1520	1595	349.8	274.8		
1805	1880	325	0.2	1870	1520	1595	350	275		
1805	1880	326	0.2	1870.2	1520	1595	350.2	275.2		
1805	1880	327	0.2	1870.4	1520	1595	350.4	275.4		
1805	1880	328	0.2	1870.6	1520	1595	350.6	275.6		
1805	1880	329	0.2	1870.8	1520	1595	350.8	275.8		
1805	1880	330	0.2	1871	1520	1595	351	276		
1805	1880	331	0.2	1871.2	1520	1595	351.2	276.2		
1805	1880	332	0.2	1871.4	1520	1595	351.4	276.4		
1805	1880	333	0.2	1871.6	1520	1595	351.6	276.6		
1805	1880	334	0.2	1871.8	1520	1595	351.8	276.8		
1805	1880	335	0.2	1872	1520	1595	352	277		
1805	1880	336	0.2	1872.2	1520	1595	352.2	277.2		
1805	1880	337	0.2	1872.4	1520	1595	352.4	277.4		
1805	1880	338	0.2	1872.6	1520	1595	352.6	277.6		
1805	1880	339	0.2	1872.8	1520	1595	352.8	277.8		
1805	1880	340	0.2	1873	1520	1595	353	278		
1805	1880	341	0.2	1873.2	1520	1595	353.2	278.2		
1805	1880	342	0.2	1873.4	1520	1595	353.4	278.4		

1805	1880	343	0.2	1873.6	1520	1595	353.6	278.6				
1805	1880	344	0.2	1873.8	1520	1595	353.8	278.8				
1805	1880	345	0.2	1874	1520	1595	354	279				
1805	1880	346	0.2	1874.2	1520	1595	354.2	279.2				
1805	1880	347	0.2	1874.4	1520	1595	354.4	279.4				
1805	1880	348	0.2	1874.6	1520	1595	354.6	279.6				
1805	1880	349	0.2	1874.8	1520	1595	354.8	279.8				
1805	1880	350	0.2	1875	1520	1595	355	280				
1805	1880	351	0.2	1875.2	1520	1595	355.2	280.2				
1805	1880	352	0.2	1875.4	1520	1595	355.4	280.4				
1805	1880	353	0.2	1875.6	1520	1595	355.6	280.6				
1805	1880	354	0.2	1875.8	1520	1595	355.8	280.8				
1805	1880	355	0.2	1876	1520	1595	356	281				
1805	1880	356	0.2	1876.2	1520	1595	356.2	281.2				
1805	1880	357	0.2	1876.4	1520	1595	356.4	281.4				
1805	1880	358	0.2	1876.6	1520	1595	356.6	281.6				
1805	1880	359	0.2	1876.8	1520	1595	356.8	281.8				
1805	1880	360	0.2	1877	1520	1595	357	282				
1805	1880	361	0.2	1877.2	1520	1595	357.2	282.2				
1805	1880	362	0.2	1877.4	1520	1595	357.4	282.4				
1805	1880	363	0.2	1877.6	1520	1595	357.6	282.6				
1805	1880	364	0.2	1877.8	1520	1595	357.8	282.8				
1805	1880	365	0.2	1878	1520	1595	358	283				
1805	1880	366	0.2	1878.2	1520	1595	358.2	283.2				
1805	1880	367	0.2	1878.4	1520	1595	358.4	283.4				
1805	1880	368	0.2	1878.6	1520	1595	358.6	283.6				
1805	1880	369	0.2	1878.8	1520	1595	358.8	283.8				
1805	1880	370	0.2	1879	1520	1595	359	284				
1805	1880	371	0.2	1879.2	1520	1595	359.2	284.2				

	1805	1880	372	0.2	1879.4	1520	1595	359.4	284.4				
	1805	1880	373	0.2	1879.6	1520	1595	359.6	284.6				
	1805	1880	374	0.2	1879.8	1520	1595	359.8	284.8				
	1805	1880	375	0.2	1880	1520	1595	360	285				



10 April 2018

Dr. Francis E. Idachaba,
Principal Investigator,
Department of Electrical and Information Engineering,
Covenant University Ota,
Ogun State, Nigeria.

Dear Sir,

AWARD OF GRANT FOR THE DEVELOPMENT OF LOW-COST GSM SYSTEM FOR RURAL AREAS

Further to your Proposal dated 26th July 2017, we are happy to inform you that your Proposal has been approved by the Commission.

The Grant awarded to you for your project by the Commission is **N9, 321,400 (Nine Million Three Hundred and Twenty One Thousand Four Hundred Naira)** only, as requested in your proposal. This amount is deemed to cover the cost of all works necessary for the timely and satisfactory completion of the Research work and this amount shall not be varied.

AWARD TERMS:

1. GRANT

This is a Research Grant for the Development of Low-Cost GSM System for Rural Area.

2. SCOPE OF RESEARCH

The scope of work as stated in your proposal includes but is not limited to the following:

- a. Procurement of Laptops, Mobile Tabs and office Consumables
- b. Procurement of Printed Circuit Board Machine (PCB) and consumables
- c. Design and Simulation of Transceiver, Procurement of Components and antennas
- d. Prototype construction, Lab Testing and Fielding Testing
- e. Analysis of Results, and submission of final Report and Prototype to the Nigerian Communications Commission

3. DELIVERABLES AND DURATION

This Grant shall run for one year except there are compelling reasons for an extension. The one year shall commence on the date of receipt of this letter. The Research Team shall submit soft and hard copies of Report of every stage of work to the Commission. The Final Research prototype must be submitted within one (1) year of the date of this Award Letter.

Stage One: Months 1

Procurement of Laptops, Mobile Tabs and office Consumables and submission of Report.

Stage Two: Months 2-3

Procurement of Printed Circuit Board Machine (PCB) and consumables and follow up Report.

Stage Three: Months 4-6

Design and Simulation of Transceiver, and Procurement of Components and antennas and submission of Report

Stage Four: Months 7-10

Prototype construction, Lab Testing and Fielding Testing and submission of Report.

Stage Five: Months 11-12

Analysis of Results, and submission of final Report and approved Prototype to the Nigerian Communications Commission.

4. PAYMENT TERMS

Payment shall be made in four (4) tranches following achievement of the following milestones:

First payment: First payment is 10% of the Grant Sum and it is subject to the submission of acceptable Project Kick off Report.

Second Payment: Second payment is 30% of the Grant Sum and it is payable subject to the submission of Stage 1 and Stage 2 deliverables.

Third Payment: Third payment is 45% of the Grant Sum and is subject to the submission of Stages 3 and Stage 4 deliverables.

Final Payment: Final Payment is 15% of the Grant Sum and it is payable subject to the submission of Stage 5 deliverables.

Please note that non fulfilment of any of the terms of this Grant will warrant a refund of all sums paid by the Commission prior to the default and a termination of the Grant. In addition, all funds disbursed must be used for the Research work only.

Please accept the assurances of the Executive Vice Chairman and Chief Executive of the Commission.

Thank you.

Yours faithfully,

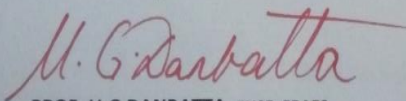

PROF. U.G DANBATT, FNSE, FRAES
EXECUTIVE VICE CHAIRMAN/CHIEF EXECUTIVE